

Grandstream Networks, Inc.

GXV3350

High-End Smart Video Phone

User Guide



COPYRIGHT

©2019 Grandstream Networks, Inc. <http://www.grandstream.com>

All rights reserved. Information in this document is subject to change without notice. Reproduction or transmittal of the entire or any part, in any form or by any means, electronic or print, for any purpose without the express written permission of Grandstream Networks, Inc. is not permitted.

The latest electronic version of this guide is available for download here:

<http://www.grandstream.com/support>

Grandstream is a registered trademark and Grandstream logo is trademark of Grandstream Networks, Inc. in the United States, Europe and other countries.

CAUTION

Changes or modifications to this product not expressly approved by Grandstream, or operation of this product in any way other than as detailed by this guide, could void your manufacturer warranty.

WARNING

Please do not use a different power adaptor with devices as it may cause damage to the products and void the manufacturer warranty.



U.S. FCC Statement

Part 68 Regulatory Information

This equipment complies with Part 68 of the FCC rules. Located on the equipment is a label that contains, among other information, the ACTA registration number and ringer equivalence number (REN). If requested, this information must be provided to the telephone company.

The REN is used to determine the quantity of devices which may be connected to the telephone line. Excessive REN's on the telephone line may result in the devices not ringing in response to an incoming call. In most, but not all areas, the sum of the REN's should not exceed five (5.0). To be certain of the number of devices that may be connected to the line, as determined by the total REN's contact the telephone company to determine the maximum REN for the calling area.

This equipment cannot be used on the telephone company-provided coin service. Connection to Party Line Service is subject to State Tariffs.

If this equipment causes harm to the telephone network, the telephone company will notify you in advance that temporary discontinuance of service may be required. If advance notice isn't practical, the telephone company will notify the customer as soon as possible. Also, you will be advised of your right to file a complaint with the FCC if you believe it is necessary. The telephone company may make change in its facilities. If this happens, the telephone company will provide advance notice in order for you to make the necessary modifications in order to maintain uninterrupted service.

If the trouble is causing harm to the telephone network, the telephone company may request you to remove the equipment from the network until the problem is resolved.

This equipment uses the following USOC jacks: RJ45C.

It is recommended that the customer install an AC surge arrester in the AC outlet to which this device is connected. This is to avoid damaging the equipment caused by local lightning strikes and other electrical surges.

Since this device has the HAC function, the earpiece is easy to absorb small, please take care to avoid scratching.

If trouble is experienced with this equipment, please contact (Agent in the US):

Company Name: Grandstream Networks, Inc.

Address: 126 Brookline Ave, 3rd Floor Boston, MA 02215, USA

Tel: 1-617-5669300

Fax: 1-617-2491987



Part 15 Regulatory Information

This device complies with part 15 of the FCC Rules. Operation is subject to the following two condition:

- (1) this device may not cause harmful interference, and
- (2) this device must accept any interference received, including interference that may cause undesired operation.

Any Changes or modifications not expressly approved by the party responsible for compliance could void the user's authority to operate the equipment.

Note: This equipment has been tested and found to comply with the limits for a Class B digital device, pursuant to part 15 of the FCC Rules. These limits are designed to provide reasonable protection against harmful interference in a residential installation. This equipment generates, uses and can radiate radio frequency energy and, if not installed and used in accordance with the instructions, may cause harmful interference to radio communications. However, there is no guarantee that interference will not occur in a particular installation. If this equipment does cause harmful interference to radio or television reception, which can be determined by turning the equipment off and on, the user is encouraged to try to correct the interference by one or more of the following measures:

- Reorient or relocate the receiving antenna.
- Increase the separation between the equipment and receiver.
- Connect the equipment into an outlet on a circuit different from that to which the receiver is connected.
- Consult the dealer or an experienced radio/TV technician for help.

This equipment complies with FCC radiation exposure limits set forth for an uncontrolled environment. This equipment should be installed and operated with minimum distance 20cm between the radiator & your body. This transmitter must not be co-located or operating in conjunction with any other antenna or transmitter.



Canada Regulatory Information

Operation of 5150-5250 MHz is restricted to indoor use only.

This device contains licence-exempt transmitter(s)/receiver(s) that comply with Innovation, Science and Economic Development Canada's licence-exempt RSS(s). Operation is subject to the following two conditions:

- (1) This device may not cause interference.
- (2) This device must accept any interference, including interference that may cause undesired operation of the device.

L'émetteur / récepteur exempt de licence contenu dans le présent appareil est conforme aux CNR d'Innovation, Sciences et Développement économique Canada applicable aux appareils radio exempts de licence. L'exploitation est autorisée aux deux conditions suivantes:

- (1) L'appareil ne doit pas produire de brouillage ;
- (2) L'appareil doit accepter tout brouillage radioélectrique subi, même si le brouillage est susceptible d'en compromettre le fonctionnement.

CAN ICES-3(B)/NMB-3(B)

The device meets the exemption from the routine evaluation limits in section 2.5 of RSS 102 and compliance with RSS-102 RF exposure, users can obtain Canadian information on RF exposure and compliance.

This equipment should be installed and operated with minimum distance 20cm between the radiator & your body. This transmitter must not be co-located or operating in conjunction with any other antenna or transmitter.

EU Regulatory Information

Support Frequency Bands and Power:

WLAN/BT 2.4 GHz < 20 dBm;

WLAN 5.2 GHz <23 dBm;

WLAN 5.3/5.6 GHz <20 dBm;

This equipment should be installed and operated with minimum distance 20cm between the radiator & your body. Transmitter must not be co-located or operating in conjunction with any other antenna or transmitter.

The simplified EU declaration of conformity referred to in Article 10(9) shall be provided as follows:

Hereby, Grandstream Networks, Inc. declares that the radio equipment type GXV3350 is in compliance with Directive 2014/53/EU.

The full text of the EU declaration of conformity is available at the following internet address:

www.grandstream.com



Table of Content

DOCUMENT PURPOSE	17
CHANGE LOG	18
Firmware Version 1.0.1.8	18
WELCOME	19
PRODUCT OVERVIEW	20
Feature Highlights	20
GXV3350 Technical Specifications	21
GETTING STARTED.....	23
Equipment Packaging	23
Description of the GXV3350	24
<i>Front View</i>	24
<i>Back View</i>	26
Connecting and Setting Up the GXV3350	28
<i>Using the Phone Stand</i>	28
<i>Using the Slots for Wall Mounting (Wall Mount *Sold Separately)</i>	28
Connecting the GXV3350	29
GBX20 Extension Module.....	29
<i>Installing the GBX20 to GXV3350</i>	30
GETTING TO KNOW GXV3350.....	32
Use the Touchscreen	32
Use the Desktop	34
<i>Desktop Menu</i>	34
<i>Add Widget to Desktop</i>	35
<i>Manage Desktop Items</i>	35
<i>Set Wallpapers</i>	37
<i>Manage Running Applications</i>	38
Idle Screen	39
<i>Switch Idle Screens</i>	39
<i>Set Up Idle Screen</i>	39



Use the Status Bar	41
Notifications in Status Bar	44
<i>System Settings in Status Bar</i>	46
Use the GXV3350 Keys	46
<i>Keypad Shortcut Functions</i>	47
Use the On-Screen Keyboard.....	48
Use the Message Waiting Indicator	49
MAKE PHONE CALLS	51
Register SIP Accounts	51
<i>Account Status</i>	51
<i>Configure SIP Account</i>	52
Dial a Number Directly	53
Redial	54
Dial a Number via Contact	54
Dial a Number via Call History	55
Direct IP Call	56
Answer a Call	56
<i>Single Incoming Call</i>	56
Preview Function for Incoming Call.....	57
Transfer Function for Incoming Call	58
<i>Multiple Calls/Call Waiting</i>	59
<i>Call Progress Status</i>	60
Call Hold	61
Call Recording	61
MPK Monitoring	62
Mute	63
Turn on Video during Audio Call	64
Call Details during Call.....	65
Quick DTMF During Call	66
Switch Audio Channel During Call	67
Call Transfer.....	67
<i>Blind Transfer</i>	67



<i>Attended Transfer</i>	68
<i>Transfer via MPKs</i>	70
6-Way Conference	72
<i>Initiate Conference</i>	72
<i>Remove Party from Conference</i>	75
<i>End Conference</i>	76
<i>Hold and Resume Conference</i>	76
<i>Auto Conference Mode</i>	76
UCM Conference	76
<i>Participate in UCM Conference Room</i>	76
<i>CCM (Conference Call Menu)</i>	77
<i>Conference Call Operations</i>	78
<i>CEI (Conference Event Indicator)</i>	80
Missed Call	80
DND (Do Not Disturb)	81
Voicemail/Message Waiting Indication	81
Call Forward.....	82
Call Features.....	84
CONTACTS.....	87
Local Contacts	87
Add Single Contacts	87
Import/Export Contacts	89
Download Contacts.....	91
Search Contacts	91
Use Contacts	92
<i>Make a Call to Contacts</i>	92
<i>Select Contacts</i>	92
<i>Add Contacts to Favorites</i>	93
<i>Edit Contacts</i>	94
<i>Send Contacts to Desktop Shortcut</i>	94
<i>Share Contacts via Bluetooth</i>	94
<i>Add Contacts to Blacklist</i>	95
<i>Add Group</i>	95
<i>Add contacts to Group</i>	95
<i>Contacts Storage Status</i>	96



PROGRAMMABLE KEYS	97
Programmable Keys Application.....	97
GBX20 Extension Boards	98
GXV3350 SETTINGS.....	100
HARASSMENT INTERCEPTION	102
Blocked Contacts	102
Block History	102
<i>Delete Block History</i>	<i>103</i>
<i>Edit Blacklist</i>	<i>103</i>
Intercept Anonymous calls	104
CALL HISTORY	106
Local Call History	106
<i>Dial Out from Call History</i>	<i>106</i>
<i>Call History Options</i>	<i>107</i>
<i>Delete Call History</i>	<i>107</i>
<i>Call History Details</i>	<i>107</i>
SMS	109
View SMS.....	109
Create New SMS	110
Delete SMS.....	110
SMS Settings	111
FILE MANAGER	112
Files Operations.....	112
<i>Copy and Paste Files.....</i>	<i>112</i>
<i>Move Files</i>	<i>113</i>
<i>Send Files.....</i>	<i>114</i>
<i>Delete Files.....</i>	<i>114</i>
<i>Rename a File</i>	<i>115</i>
File Categories.....	116
GS MARKET.....	117



FTP SERVER	118
StateDetection	120
CAMERA	122
Take Picture	122
Record Video	122
Angle Adjustment	123
Gallery.....	123
Screensaver.....	126
BROWSER	128
ACTION URL	130
CONNECTING GXV3350 TO DOOR SYSTEMS	131
CONNECT TO NETWORK AND DEVICES	132
Ethernet	132
WI-FI	132
<i>Turn On/Off Wi-Fi</i>	132
<i>Connect to Wi-Fi Networks</i>	132
<i>Wi-Fi Settings Shortcut</i>	135
Bluetooth.....	136
<i>Turn On/Off Bluetooth</i>	136
<i>Change Bluetooth Device Name</i>	136
<i>Pair GXV3350 with a Bluetooth Device</i>	136
<i>Unpair a Bluetooth Device</i>	137
<i>Bluetooth Settings Shortcut</i>	137
EHS Headset	139
USB Headset	139
USB.....	140
EMERGENCY CALL	142
EXPERIENCING THE GXV3350 APPLICATION PHONE	144



Table of Tables

Table 1: GXV3350 Features in a Glance	20
Table 2: GXV3350 Technical Specifications.....	21
Table 3: Equipment Packaging	23
Table 4: GXV3350 Front View.....	25
Table 5: GXV3350 Back View	26
Table 6: GBX20 Extension Module Packaging	30
Table 7: GXV3350 Status Bar Notification Icons	44
Table 8: GXV3350 Keys	47
Table 9: GXV3350 MWI LED Status	50
Table 10: GXV3350 Feature Code	84



Table of Figures

Figure 1: GXV3350 Package Content.....	23
Figure 2: GXV3350 Front and GBX20 Extension Module Front.....	24
Figure 3: GXV3350 Back View.....	26
Figure 4: Phone Stand and Mounting Slots on GXV3350	28
Figure 5: Tab on The Handset Cradle	29
Figure 6: GXV3350 Back / Side View	29
Figure 7: GBX20 with connector	30
Figure 8: Connect GXV3350 and GBX20	30
Figure 9: GXV3350 Default Home Screen.....	32
Figure 10: GXV3350 Onscreen Menu.....	32
Figure 11: GXV3350 Finger Gestures on the Touch Screen.....	33
Figure 12: GXV3350 Desktop Menu	34
Figure 13: Add Widget to the Desktop	35
Figure 14: Open Clock Widget.....	36
Figure 15: Resize Digital Clock Widget.....	36
Figure 16: Move Clock Widget	37
Figure 17: GXV3350 Choose Wallpaper.....	38
Figure 18: GXV3350 Recent Applications.....	38
Figure 19: GXV3350 Switch Idle Screens.....	39
Figure 20: Set up Home Idle Screen.....	40
Figure 21: Add an Idle Screen	40
Figure 22: Delete an Idle Screen	41
Figure 23: GXV3350 Top Status Bar.....	41
Figure 24: Status Bar - More Options	42
Figure 25: GXV3350 Top Status Bar – Notification.....	42
Figure 26: GXV3350 Top status Bar - Get more information	43
Figure 27: GXV3350 Top status Bar – Wi-Fi.....	43
Figure 28: System Settings in Status Bar	46
Figure 29: GXV3350 Keys	46
Figure 30: GXV3350 Onscreen Keyboard - English Keyboard.....	48
Figure 31: GXV3350 Onscreen Keyboard - Lowercase and Uppercase	48
Figure 32: English Keyboard - Number and Symbols.....	49
Figure 33: English Keyboard - More Symbols	49
Figure 34: GXV3350 Account Widget	51
Figure 35: GXV3350 Dial Screen.....	52
Figure 36: Disable Video Call Feature on Dial Screen	53
Figure 37: GXV3350 View Contacts	55



Figure 38: GXV3350 Call History	55
Figure 39: Single Incoming Call – Audio	56
Figure 40: Single Incoming Call – Video	57
Figure 41: Single Incoming Call – Preview-1	58
Figure 42: Single Incoming Call – Preview-2	58
Figure 43: Single Incoming Call – Transfer-1.....	59
Figure 44: Single Incoming Call – Transfer-2.....	59
Figure 45: Call Waiting	60
Figure 46: Touch to Return to Call Screen	60
Figure 47: Call on Hold	61
Figure 48: GXV3350 Call Recording.....	61
Figure 49: MPK button	62
Figure 50: MPK list.....	63
Figure 51: GXV3350 Call Mute	63
Figure 52: Turn on Video During Audio Call.....	64
Figure 53: Accept Video During Audio Call	64
Figure 54: Select Call Details During Video Call.....	65
Figure 55: Call Details.....	65
Figure 56: Select Quick DTMF During Call.....	66
Figure 57: DTMF During Call	66
Figure 58: Blind Transfer	67
Figure 59: Attended Transfer.....	68
Figure 60: Attended Transfer - Transferring.....	69
Figure 61: Attended Transfer – Split	69
Figure 62: Attended Transfer.....	70
Figure 63: Transfer via MPK	71
Figure 64: MPK list.....	71
Figure 65: Add Conference Members from Dial Screen	72
Figure 66: Add Conference Members from Dial Screen 2	72
Figure 67: GXV3350 Conference Screen	73
Figure 68: GXV3350 Conference - Add Existing Call to Conference	74
Figure 69: 3-Way Conference Call Established	74
Figure 70: Notification of joining the conference.....	75
Figure 71: Notification of exiting the conference.....	75
Figure 72: GXV3350 Conference - Remove Party from Conference.....	76
Figure 73: Join UCM Conference Room.....	77
Figure 74: UCM conference Menu	77
Figure 75: Conference Menu Options.....	78
Figure 76: Conference’s members list	78
Figure 77: Invite a member	79
Figure 78: Conference Bridge.....	79
Figure 79: Mute all members	80
Figure 80: Missed Call Screen	80



Figure 81: Enable/Disable DND	81
Figure 82: Retrieve Voicemail	82
Figure 83: Unconditional Call Forward.....	83
Figure 84: Call Forward – Unconditional.....	83
Figure 85: Call Forward - Time Based	83
Figure 86: Call Forward - Busy/No Answer/DND	84
Figure 87: GXV3350 Contacts	87
Figure 88: GXV3350 Contacts - Add New Contact.....	88
Figure 89: Add to Contacts from Dial Pad.....	89
Figure 90: GXV3350 Contacts - Import Contacts	90
Figure 91: GXV3350 Contacts - Export Contacts	90
Figure 92: GXV3350 Contacts - Download Contacts	91
Figure 93: GXV3350 Contacts - Search Contacts	92
Figure 94: GXV3350 Contacts - Select Contacts.....	93
Figure 95: Add Contacts to Favorites.....	94
Figure 96: GXV3350 Contacts - Add New Group	95
Figure 97: GXV3350 Contacts - Storage Status	96
Figure 98: GXV3350 Programmable Key APP – Add Number	97
Figure 99: GXV3350 Programmable Key APP – Add number from Contacts	98
Figure 100: GXV3350 Programmable Key APP – Number List.....	98
Figure 101: GXV3350 Settings	100
Figure 102: List of blocked contacts	102
Figure 103: Block History	102
Figure 104: GXV3350 Blacklist - Add Number to Blacklist	103
Figure 105: Manually Add Number to Blacklist	104
Figure 106: Intercept Anonymous Calls	105
Figure 107: GXV3350 Call History	106
Figure 108: GXV3350 Call History – Options	107
Figure 109: GXV3350 Call History - Details.....	108
Figure 110: GXV3350 SMS Message	109
Figure 111: View SMS Dialog.....	109
Figure 112: Create a New SMS	110
Figure 113: GXV3350 File Manager – Copy File	112
Figure 114: Paste File	113
Figure 115: GXV3350 File Manager - Move	113
Figure 116: GXV3350 File Manager - Options.....	114
Figure 117: Delete File(s) via File Manager	115
Figure 118: Rename File	116
Figure 119: GS Market – Onscreen Menu.....	117
Figure 120: FTP Server – Start	118
Figure 121: FTP Server – Stop	118
Figure 122: FTP Server – Settings.....	119
Figure 123: StateDetection APP	120



Figure 124: General Detection	120
Figure 125: Audio Detection.....	121
Figure 126: GXV3350 Camera.....	122
Figure 127: Recent pictures and videos page	123
Figure 128: Edit picture	124
Figure 129: Access to the Gallery	124
Figure 130: GXV3350 Gallery.....	125
Figure 131: GXV3350 Gallery - Picture Options	125
Figure 132: Screensaver settings	126
Figure 133: Use Network Images	127
Figure 134: Network Image Path	127
Figure 135: GXV3350 Web Browser.....	128
Figure 136: GXV3350 Browser Menu Options.....	128
Figure 137: Open New Window in Browser	129
Figure 138: GXV3350 Web Browser-Bookmarks	129
Figure 139: Incoming call from GDS3710 door system	131
Figure 140: GXV3350 Connect to Wi-Fi	133
Figure 141: GXV3350 Connect to Wi-Fi-Show Advanced Options.....	134
Figure 142: Wi-Fi - Add network	134
Figure 143: Wi-Fi Settings Shortcut.....	135
Figure 144: Wi-Fi Shortcut - Wi-Fi List.....	135
Figure 145: GXV3350 Bluetooth - Paired Device	137
Figure 146: Bluetooth Settings Shortcut	138
Figure 147: Bluetooth Setting shortcut 2.....	138
Figure 148: EHS headset.....	139
Figure 149: USB Headset Connected.....	140
Figure 150: USB Headset Used for Call	140
Figure 151: USB Storage Device Connected to GXV3350.....	141
Figure 152: Emergency Access under GXV3350 Locked Screen	142
Figure 153: Emergency Dial Screen	142

DOCUMENT PURPOSE

This document describes how to configure the GXV3350 via phone's LCD menu and web UI menu to fully manipulate phone's features. To learn advanced functions of GXV3350, please visit <http://www.grandstream.com/support> to download the latest "GXV3350 Administration Guide".

This guide covers following topics:

- [Product Overview](#)
- [Getting started](#)
- [Getting to know GXV3350](#)
- [Make phone calls](#)
- [Contacts](#)
- [GXV3350 Settings](#)
- [Harassment Interception](#)
- [Call history](#)
- [SMS](#)
- [File manager](#)
- [GS Market](#)
- [FTP Server](#)
- [StateDetection](#)
- [Camera](#)
- [Browser](#)
- [Action URL](#)
- [Connecting GXV3350 to Door Systems](#)
- [Connect to network and devices](#)
- [Emergency call](#)
- [Experiencing the GXV3350 applications](#)



CHANGE LOG

This section documents significant changes from previous versions of user guide for GXV3350. Only major new features or major document updates are listed here. Minor updates for corrections or editing are not documented here.

Firmware Version 1.0.1.8

- This is the initial version.



WELCOME

Thank you for purchasing Grandstream GXV3350 High-End Smart Video Phone for Android™. The GXV3350 IP Video Phone for Android combines a 16-line IP video phone with a multi-platform video collaboration solution and the functionality of an Android tablet to offer an all-in-one communications solution. This IP video phone delivers a powerful experience through its' 5 inch 1280x720 capacitive touch screen, tiltable camera, HDMI output, dual microphones and support for 720p HD video. The GXV3350 adds dual Gigabit ports with PoE/PoE+, integrated Wi-Fi and Bluetooth support. It also runs Android 7.0 and offers instant access to hundreds of thousands of Android apps. By combining a state-of-the-art IP video phone, an advanced video collaboration solution, and the functionality of an Android tablet, the GXV3350 offers businesses throughout the world a powerful desktop communication and productivity solution.



PRODUCT OVERVIEW

Feature Highlights

The following tables contain the major features of the GXV3350:

Table 1: GXV3350 Features in a Glance

 <p>GXV3350</p>	<ul style="list-style-type: none"> • 16 lines with up to 16 SIP accounts, up to 6-way audio conference and 3-way 720p 30fps HD video conference, phonebook with up to 1000 contacts, call history with up to 1000 records. • Dual switched 10/100/1000Mbps network ports, Dual-band 2.4GHz & 5GHz Wi-Fi (802.11a/b/g/n), PoE/PoE+, Bluetooth 4.2+EDR, USB, HDMI, EHS with Plantronics headsets support. • 5" (1280x720) capacitive (5 points) touch screen TFT LCD, mega pixel CMOS sensor camera with privacy shutter. • Dual MIC & HD speakerphone with noise reduction, advanced echo cancellation and excellent double-talk performance. • Runs the Android™ Operating System 7.0. • Built-in support for GXV series of video surveillance cameras, and GDS37xx series of access control devices. • Create Android applications for any business need to run on GXV3350 using Grandstream's SDK toolkit.
--	---

GXV3350 Technical Specifications

The following table resumes all the technical specifications including the protocols / standards supported, voice codecs, telephony features, languages and upgrade/provisioning settings for the phone GXV3350.

Table 2: GXV3350 Technical Specifications

Protocols/Standards	SIP RFC3261, TCP/IP/UDP, RTP/RTCP, HTTP/HTTPS, ARP, ICMP, DNS (A record, SRV, NAPTR), DHCP, PPPoE, SSH, TFTP, NTP, STUN, SIMPLE, LLDP-MED, LDAP, TR-069, 802.1x, TLS, SRTP, IPv6, OpenVPN®
Network Interfaces	Dual switched 10/ 100/ 1000 Mbps ports with integrated PoE/PoE+
Graphic Display	5 inch 1280x720 capacitive touch screen (5 points) TFT LCD
Camera	Tilttable 1 mega-pixel CMOS camera with privacy shutter, 720P@30fps
Bluetooth	Yes, integrated. Bluetooth 4.2+EDR.
Wi-Fi	Yes, dual-band (2.4GHz & 5GHz) with 802.11 a/b/g/n
Auxiliary Ports	RJ9 headset jack (allowing EHS with Plantronics headsets), USB port, HDMI-out (1.4 up to 720p30fps)
Feature Keys	11 functions keys for CONFERENCE, TRANSFER, SEND/REDIAL, MUTE, EARPHONE, SPEAKERPHONE, VOLUME +/- . 3 dedicated Android keys for HOME, MENU, and BACK
Voice Codec	Wide-band Opus, wide-band G.722, G.711μ/a, G. 729A/B, G.726-32, iLBC, in-band and out-of-band DTMF (In audio, RFC2833, SIP INFO), VAD, CNG, AEC, PLC, AJB, AGC, ANS
Video Codec and Capabilities	H.264 BP/MP/HP, video resolution up to 720p, frame rate up to 30 fps, bit rate up to 2Mbps, 3-way video conference (720p@30fps), anti-flickering, auto focus and auto exposure
Telephony Features	Hold, transfer, forward (unconditional/no-answer/busy), call park/pickup, 6-way audio conference(including the host), shared-call-appearance (SCA) / bridged-line-appearance (BLA), virtual Programmable Key, downloadable contacts (XML, LDAP, up to 1000 items), call record(local and server), call log (up to 1000 records), call waiting, auto answer, XML customization of screen, click-to-dial, flexible dial plan, hot desking, personalized music ringtones and music on hold, server redundancy & fail-over
Sample Applications	Local apps: Contacts, Call History, File Manager, Programmable Key, Settings, Browser, Voicemail, Clock, Calculator, Recorder, GS Market, etc. Support third-party Android apps API/SDK available for advanced custom application development
Applications Deployment	Support Android 7.0 compliant applications to be developed, downloaded and run on the device with provisioning control



HD Audio	Yes, 2 omnidirectional microphones, HD handset and speakerphone with support for wideband audio
Base Stand	Yes, base stand with three adjustable levels
Extension Module	Yes, can power up to 4 GBX20 EXT modules which feature a 272x480 color LCD, 20 quick-dial/ BLF keys with dual-color LED, 2 navigation keys and less than 1.2W power consumption per unit <i>*The second GBX20 must be powered on by a 12V/1A PSU when 2 or more GBX20 extension modules are connected to GXV3350</i>
QoS	Layer 2 QoS (802.1Q, 802.1p) and Layer 3 (ToS, DiffServ, MPLS) QoS
Security	User and administrator level passwords, MD5 and MD5-sess based authentication, 256bit-AES encrypted configuration file, TLS, SRTP, HTTPS, 802.1x media access control
Multi-language	English, German, Italian, French, Spanish, Portuguese, Russian, Croatian, Chinese, Korean, Japanese, and more
Upgrade/ Provisioning	Firmware upgrade via TFTP / HTTP / HTTPS or local HTTP upload, mass provisioning using TR-069 or AES encrypted XML configuration file
Power and Green Energy Efficiency	Universal power adapter included: Input: 100-240VAC 50-60Hz; Output 12VDC 1.5A Integrated PoE* 802.3af Class 3, PoE+ 802.3at, Class 4
Physical information	Dimension: 210mm (L) x 243mm (L) x 47.5mm (H) Unit weight: 1.24kg Package weight: 1.67kg
Temperature and Humidity	Operation: 0°C to 40°C Storage: -10°C to 60°C Humidity: 10% to 90% Non-condensing
Package Content	GXV3350 phone, handset with cord, base stand, universal power supply, network cable, quick installation guide, brochure, GPL license
Compliance	FCC: Part 15 Class B; Part 15 Subpart C(15.247); Part 15 Subpart E(15.407); Part 68 HAC IC: RSS-247; RSS-Gen; RSS-102; IECS-003; CS03 CE: EN 55032; EN 55035; EN 61000-3-2; EN 61000-3-3; EN 62368-1; EN 301 489-1; EN 301 489-17; EN 300 328; EN 301 893; EN 62311 RCM: AS/NZS CISPR 32; AS/NZS 4268; AS/NZS 62368.1; AS/CA S004



GETTING STARTED

This chapter provides basic installation instructions including the list of the packaging contents and also information for obtaining the best performance with the GXV3350.

Equipment Packaging

Table 3: Equipment Packaging

GXV3350
<ul style="list-style-type: none"> 1x GXV3350 Main Case. 1x Handset. 1x Phone Cord. 1x Phone Stand 1x Ethernet Cable. 1x 12V Power Adapter. 1x Quick Installation Guide. 1x GPL License.

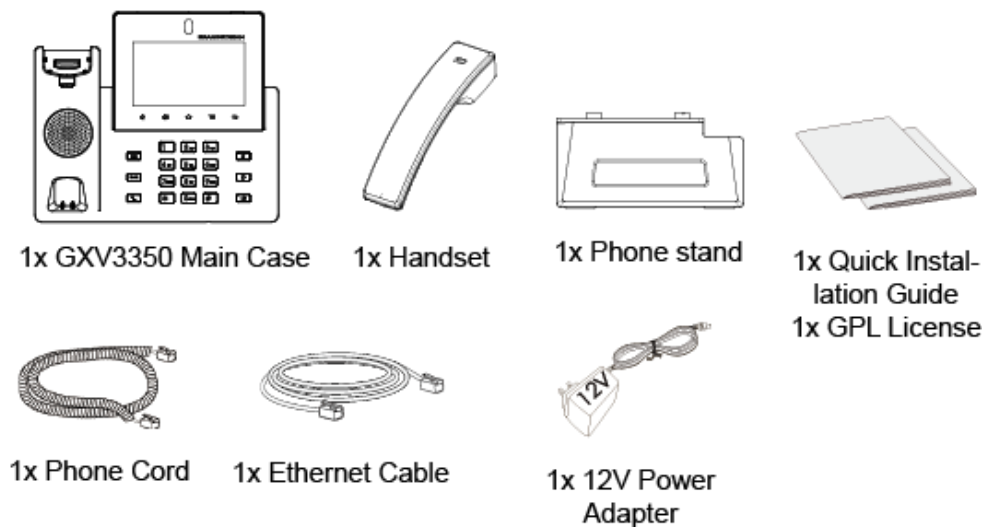

Figure 1: GXV3350 Package Content

Note: Check the package before installation. If you find anything missing, contact your system administrator.

Description of the GXV3350

Front View

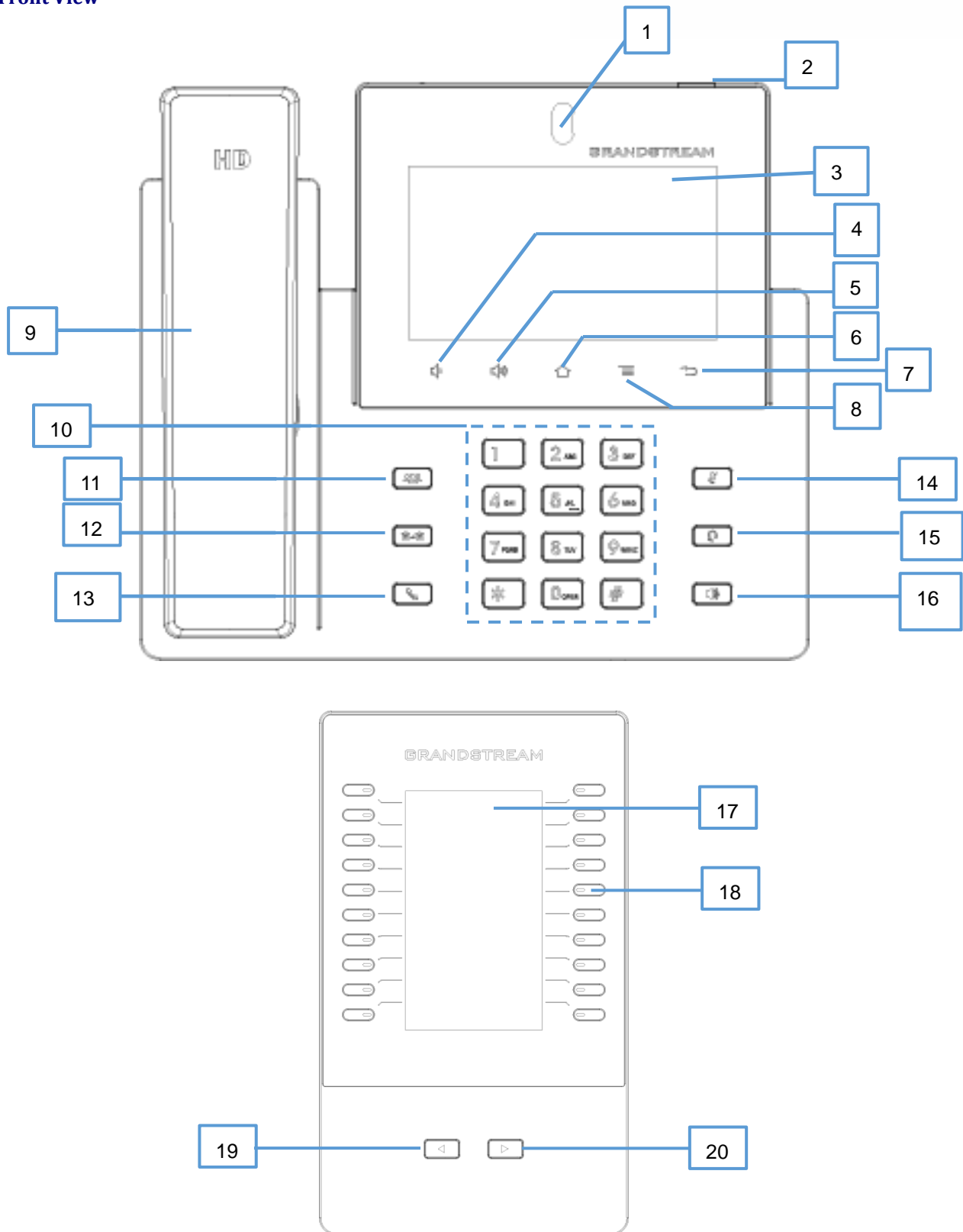

Figure 2: GXV3350 Front and GBX20 Extension Module Front

Table 4: GXV3350 Front View

Item	Name	Description
1	Front Camera	Mega pixel front camera. The angle can be adjusted, and the camera can be blocked by scrolling up/down the wheel on the back of the camera.
2	MWI LED Indicator	To indicate message status, call status and phone's system status using the LED indicator.
3	LCD	5 (1280*720) capacitive (5 points) touch screen.
4	Volume Down	Tap to turn down the call volume and media volume.
5	Volume Up	Tap to turn up the call volume and media volume.
6	Home	Tap to go back to Home screen; or touch and press for about 2 seconds to take a screenshot of phone's screen.
7	Menu	Press MENU key to access phone's display settings, edit widgets and thread manager. Or press and hold on the MENU key for 2 seconds to enter managing application interface directly.
8	Back	Tap to go back to the previous menu.
9	Handset	Off hook to use handset as the audio channel for calls and media.
10	Keypad	Tap to dial or send DTMF
11	Conference	Tap to enter into conference, then make an online meeting
12	Transfer	Tap to transfer the call
13	Dial/Send	Tap to make a call
14	Mute	Mute / Unmute the call. Or enable DND when free
15	Earphone	Tap to enter into the dial interface or switch the media channel to earphone
16	Speaker	Tap to enter into the dial interface or switch the media channel to speaker
17	GBX20 LCD	272*480 color LCD
18	Multiple Button	Tap to make all kinds of call, like speed dial, BLF and so on
19	Turn Last Page	Turn last page
20	Turn Next Page	Turn next page

Back View

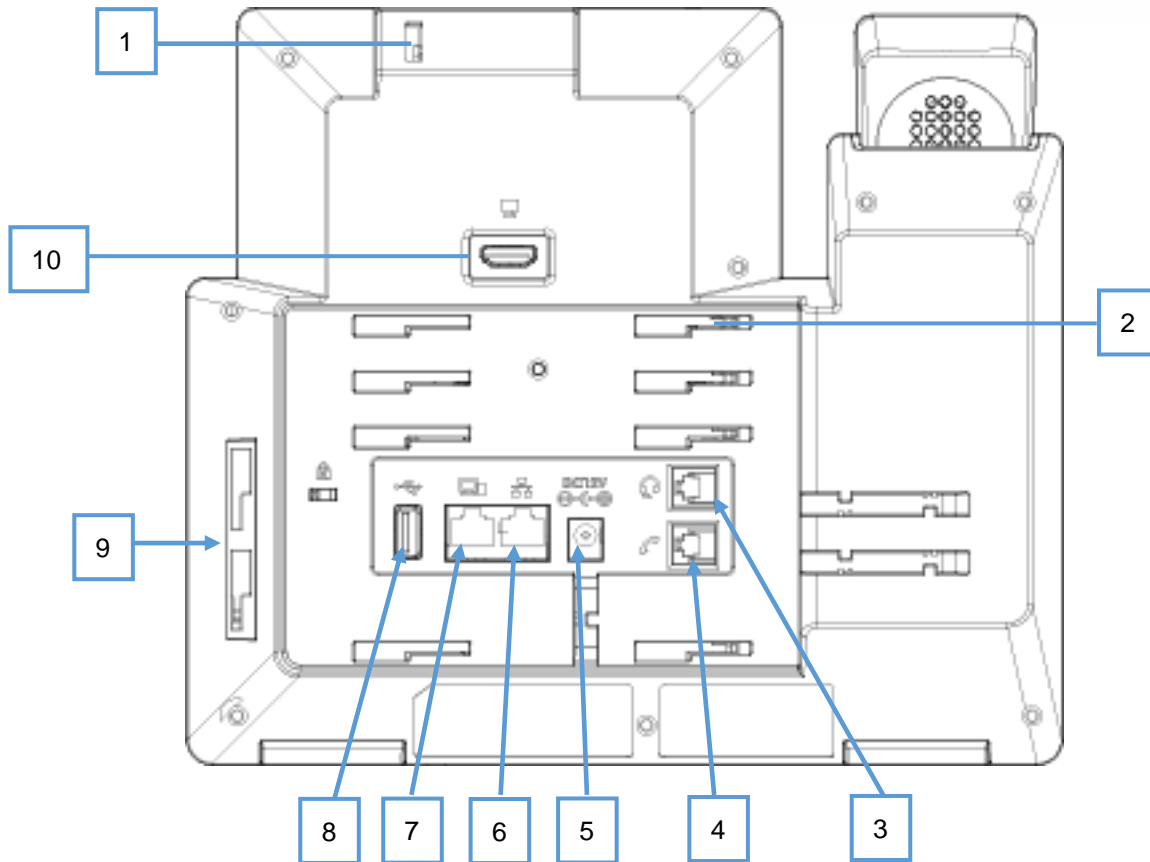

Figure 3: GXV3350 Back View

Table 5: GXV3350 Back View

Item	Name	Description
1	Camera Adjusting Wheel	Scroll up/down to adjust the camera angle.
2	Phone Stand Slot	Put the phone stand from left to right into the slots.
3	Handset Port	RJ9 handset connector port.
4	Headset Port	RJ9 headset connector port (supporting EHS with Plantronics headset).
5	Power Jack	12V DC Power connector port.
6	LAN Port	10/100/1000Mbps RJ-45 port connecting to Ethernet. PoE/PoE+ is supported.
7	PC Port	10/100/1000Mbps RJ-45 port connecting to PC.

8	USB Port	USB devices can be connected via the USB port. For example, connect a USB flash drive to save captured pictures.
9	Side GBX20 Connection Slot	The slots for connecting GXV3350 and GBX20.
10	HDMI-out Port	Connect display device to the HDMI port via HDMI cable.

Connecting and Setting Up the GXV3350

The GXV3350 can be installed on the desktop using the built-in stand or attached on the wall using the slots for wall mounting.

Using the Phone Stand

The GXV3350 has a phone stand. To set up the GXV3350 as your desk phone, follow the steps below:

1. For installing the phone on the table with the phone stand, attach the phone stand to the bottom of the phone where there is a slot for the phone stand, (upper half, bottom part);
2. Connect the handset and main phone case with the phone cord;
3. Connect the LAN port of the phone to the RJ-45 socket of a hub/switch or a router (LAN side of the router) using the Ethernet cable;
4. Connect the 12V DC output plug to the power jack on the phone; plug the power adapter into an electrical outlet. If PoE switch is used in step 3, this step could be skipped;

The LCD will display the booting up screen or firmware upgrading information. Before continuing, please wait for the main screen display to show up.

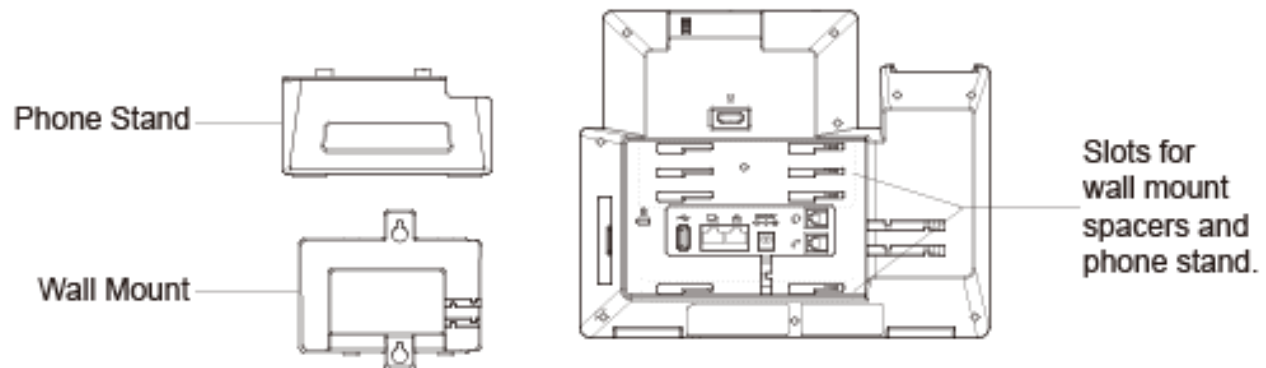

Figure 4: Phone Stand and Mounting Slots on GXV3350

Using the Slots for Wall Mounting (Wall Mount *Sold Separately)

1. Attach the wall mount to the slots for wall mount spaces on the back of the phone;
2. Attach the phone to the wall via the wall mount hole;
3. Pull out the tab from the handset cradle (see figure below);
4. Rotate the tab and plug it back into the slot with the extension up to hold the handset while the phone is mounted on the wall.
5. Connect the handset and main phone case with the phone cord;
6. Connect the LAN port of the phone to the RJ-45 socket of a hub/switch or a router (LAN side of the router) using the Ethernet cable;
7. Connect the 12V DC output plug to the power jack on the phone; plug the power adapter into an electrical outlet. If PoE switch is used in step 3, this step could be skipped;

The LCD will display the booting up screen or firmware upgrading information. Before continuing, please wait for the main screen display to show up.

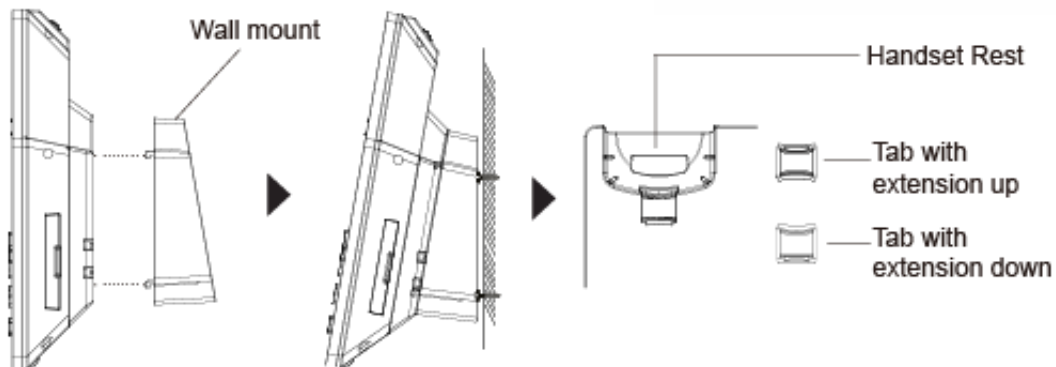

Figure 5: Tab on The Handset Cradle

Connecting the GXV3350

To setup your GXV3350, please follow the steps below:

1. Connect the handset and main phone case with the phone cord;
2. Connect the LAN port of the phone to the RJ-45 socket of a hub/switch or a router (LAN side of the router) using the Ethernet cable;
3. Connect the 12V DC output plug to the power jack on the phone; plug the power adapter into an electrical outlet. If PoE switch is used in step 2, this step could be skipped;
4. The LCD will display booting up or firmware upgrading information. Before continuing, please wait for the main screen display to show up;
5. Using the web configuration interface or from the menu of the touch screen, you can further configure network connection using static IP, DHCP etc.

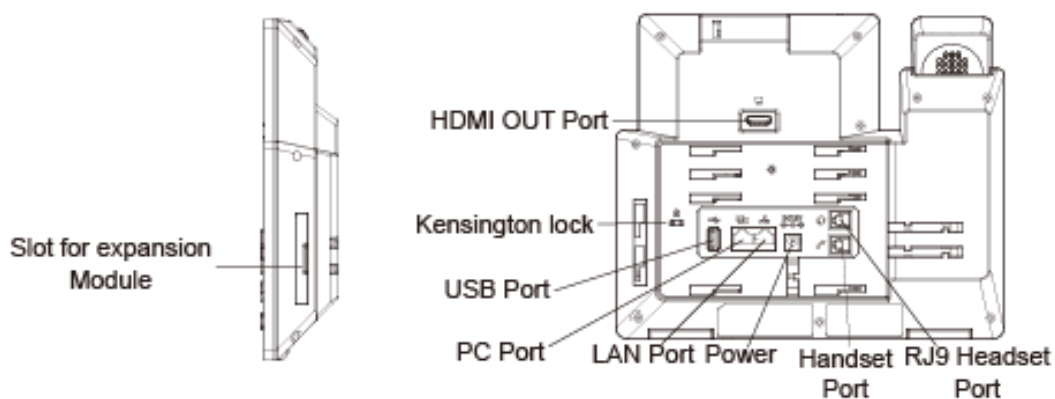

Figure 6: GXV3350 Back / Side View

GBX20 Extension Module

The GXV3350 uses GBX20 as the extension module. The extension module is an ideal solution for the busy enterprise environment looking to add the ability to receive and dispatch calls efficiently. Each GBX20 extension module has 20 programmable buttons, Left and Right buttons, supporting 40 Multiple Purpose

Keys to be configured. GXV3350 supports up to 4 extension modules, adding 160 fully programmable phone extensions to the phone.

Table 6: GBX20 Extension Module Packaging

- 1x GBX20.
- 1x GBX20 Stand.
- 1x Connector.
- 1x TypeA-MicroB USB Cable.
- 1x 12V/1A Power Adapter.
- 1x Screw.
- 1x Quick Installation Guide.

 **Note:**

1. The GBX20 is an additional accessory for the GXV3350. Therefore, the GBX20 (including extension module accessories for installation) is not included in the GXV3350 package.
2. In case two or more GBX20 extension modules are connected to the GXV3350, the second GBX20 needs to be powered on by a 12V/1A PSU.

Installing the GBX20 to GXV3350

To set up the GBX20 with the GXV3350, please follow the steps below:

1. On the back of the GBX20 and the GXV3350 there are slots for connector plate. Attach the connector plate between the slots for the GBX20, Apply the screw provided and securely tighten the connector plate to the GBX20 (see figure below).

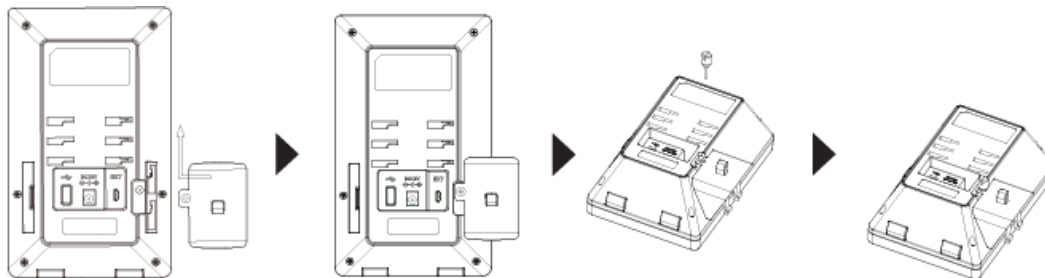

Figure 7: GBX20 with connector

2. Attach the other side of the connector plate to the GXV3350's EXT slots like shown in the figure below:

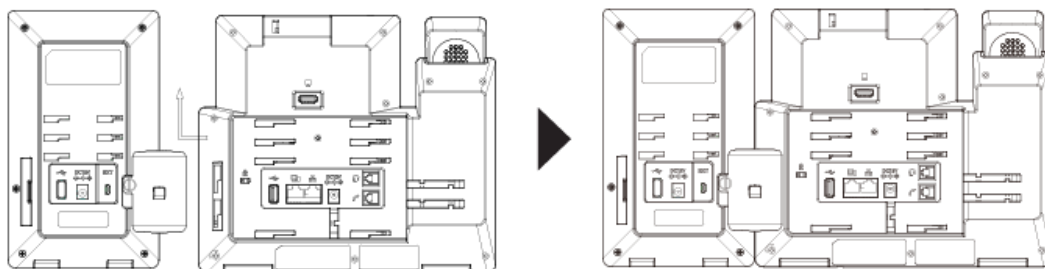

Figure 8: Connect GXV3350 and GBX20

3. Connect the GBX20 to the GXV3350 via the USB port using the USB cable provided with the GBX20.
4. Install the phone stands on the GXV3350 and the GBX20.
5. Power up the GXV3350. The GBX20 will show the booting up screen with version information and connecting status.
6. After successfully booting up, the extension board will stay in idle. Press and hold the LEFT and RIGHT button at the same time to check the version information and status.

The GBX20 can be configured via the web GUI of the GXV3350 connected. After successfully configured, press LEFT and RIGHT button on the GBX20 and users could browse all the Programmable Keys' status in different pages.

For more information on installing, connecting and configuring the GBX20 with GXV3350, please refer to the GBX20 user manual in <http://www.grandstream.com/support>.



GETTING TO KNOW GXV3350

Use the Touchscreen

When the phone boots up in HOME screen, the LCD will display as below. A registered account is shown in the following figure and users might need register their own account to have the account status displayed.

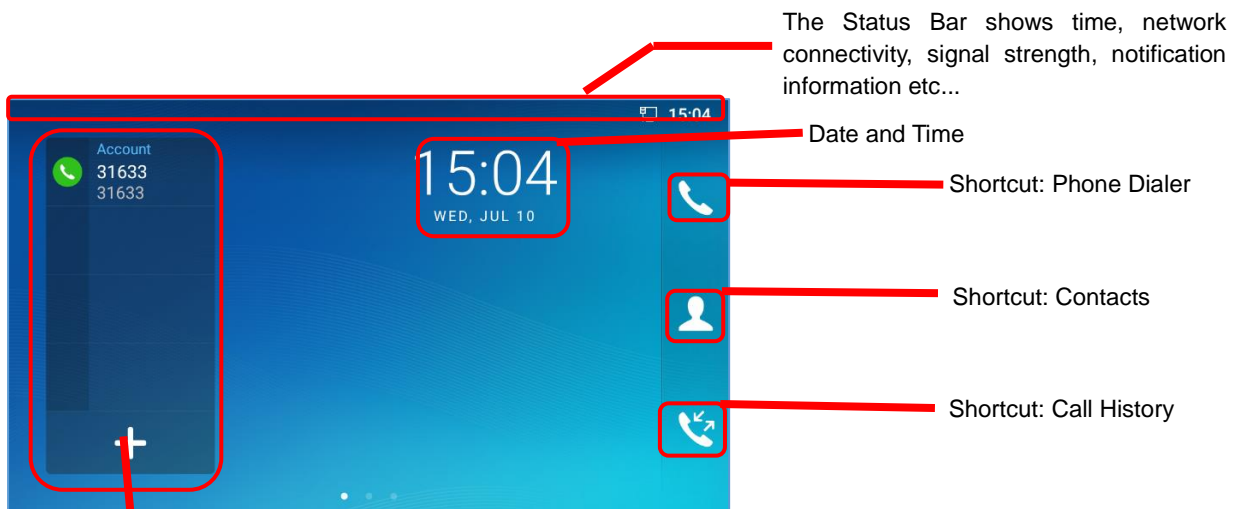

Figure 9: GXV3350 Default Home Screen

Account information Widget. Up to 6 accounts/Programmable-keys can be displayed.

Swipe from right to show the application menu of the phone. The settings and applications installed will be brought up as shown below.

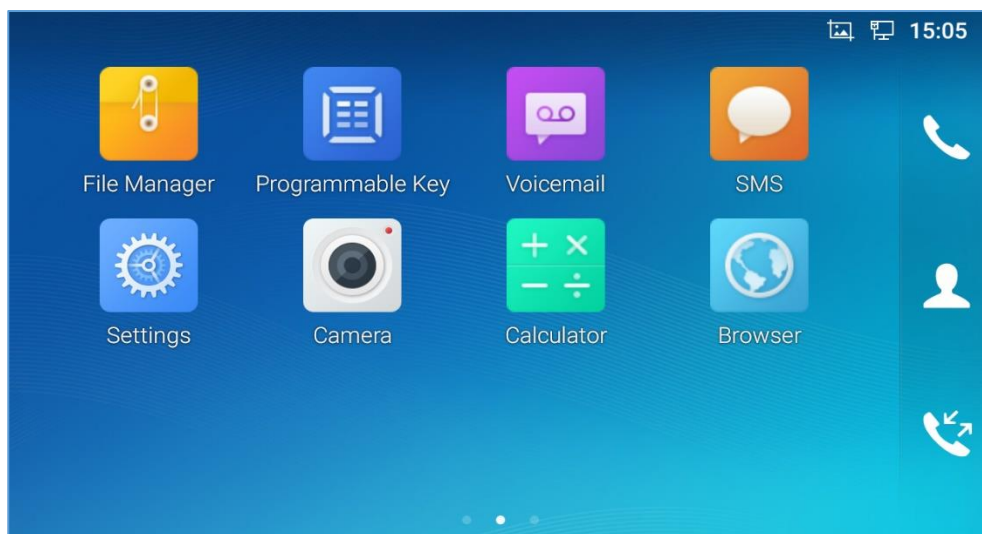

Figure 10: GXV3350 Onscreen Menu

To fully manipulate the GXV3350 capacitive touch screen, use your fingers to operate the following on the GXV3350 icons, buttons, menu items, onscreen keyboard etc.

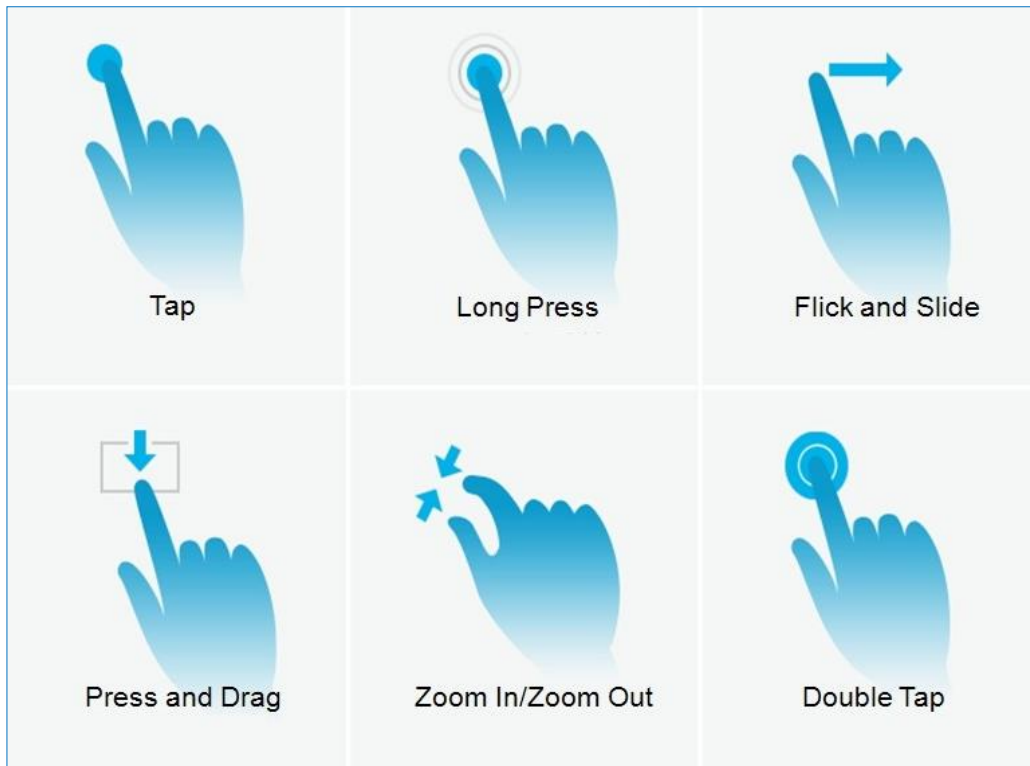



Figure 11: GXV3350 Finger Gestures on the Touch Screen

- Tap**
 Slightly touch the screen with fingertip to initiate menu, options or applications. For example, to select items on the screen (e.g., setting options, apps etc.); to press onscreen buttons (e.g., "End" or "Options" softkey during the call); to type letters and symbols using the onscreen keyboard.
- Long Press**
 Touch the screen with fingertip and press for about 2 seconds without lifting your finger from the screen till an action occurs. For example, long press on a picture to bring up selection option.
- Flick and Slide**
 Touch the screen with fingertip and slide over the screen. For example, user could slide up to scroll up the page, slide down to open dropdown menu, slide left or slide right to delete an item from the list. If your finger stays on the screen for too long, the item may be selected, and sliding won't occur.
- Press and Drag**
 Touch and press the item, then move it by dragging it up, down, left or right, without lifting your finger from the screen.

- **Zoom In/Zoom Out**
Place two fingers on the screen, then pinch them together (zoom out) or spread them apart (zoom in).
- **Double Tap**
Quickly touch the screen twice with fingertip to switch between default display and zoomed-in display. This is usually used when viewing photos or web pages.

Use the Desktop

Desktop Menu

When the GXV3350 is on idle screen, press the MENU key  to bring up phone's menu. Users can access the following in the desktop menu:

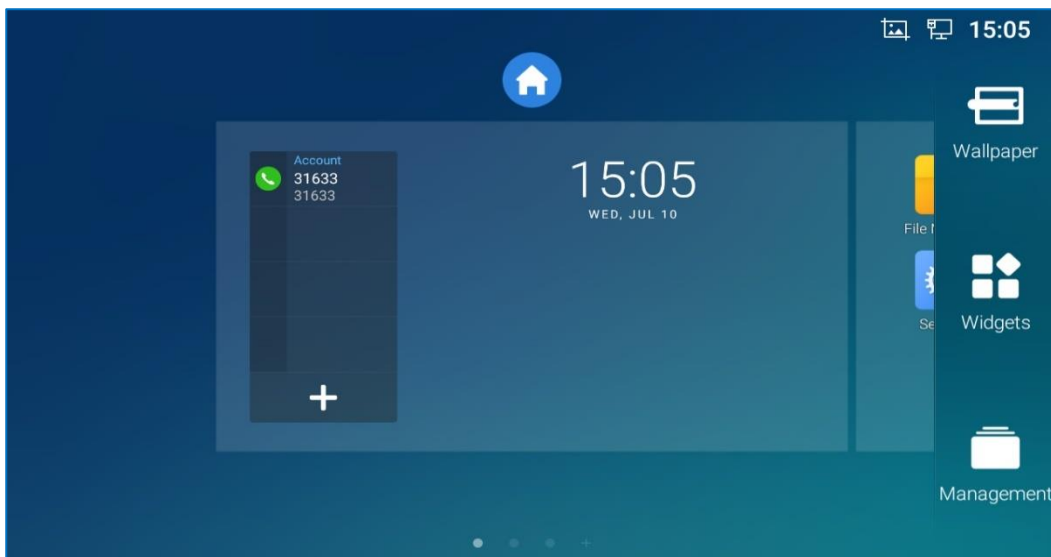



Figure 12: GXV3350 Desktop Menu

- **Desktop page**
Add, delete or edit desktop pages, set Home page and change the screen sequence.
- **Wallpaper**
Select wallpaper from Local gallery or from the available system Wallpapers
- **Widgets**
Add widgets to the desktop by touching and holding the widget from the widget menu.
- **Management**
Manage running applications on the GXV3350. For more details, please refer to section **[Manage Running Applications]**.

Add Widget to Desktop

The GXV3350 provides widgets like account bar, clock, contacts etc. Users could conveniently add those widgets to the desktop as preferred. To add a widget:

1. Press the Menu key  or long press on an empty space on the idle screen and select "Widgets".
2. Different widgets will be displayed on the right side of the screen.
3. Select and drag the widget to the desired spot to be placed on the desktop. Please make sure there is enough space on the desktop. Otherwise, the widget won't be added.

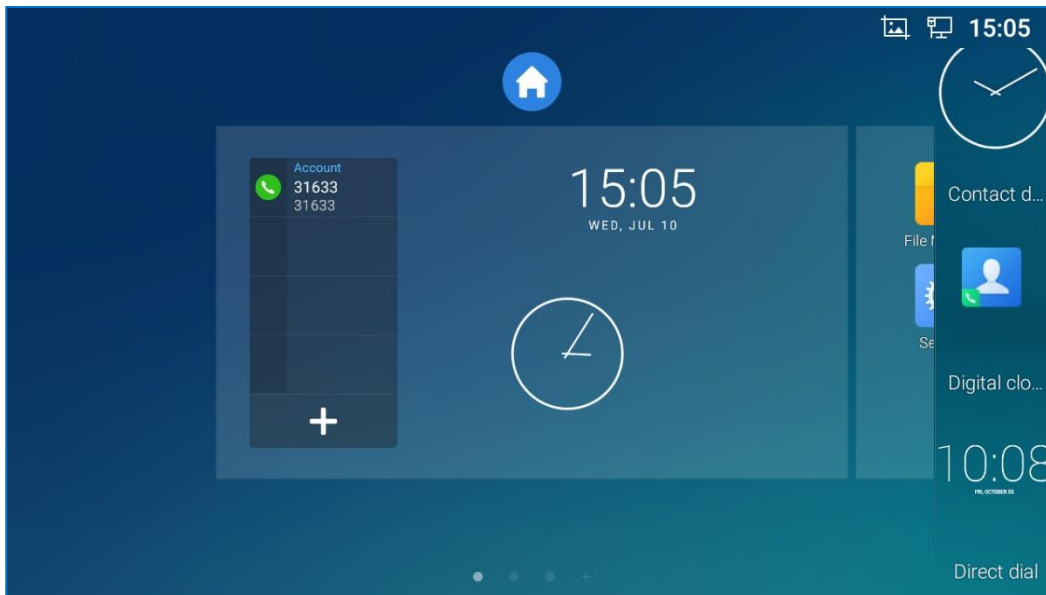

Figure 13: Add Widget to the Desktop

Manage Desktop Items

On the GXV3350 desktop, users could tap on the desktop items to manage shortcuts and widgets. The following operations can be done:

- **Tap on the shortcut icon to open the application.**

For example, tap on "File Manager" icon  to access file manager application.

- **Tap on the widget to open and edit it.**

For example, tap on the digital clock on the desktop. The clock settings will be brought up for users to set up timer, stopwatch or alarm.

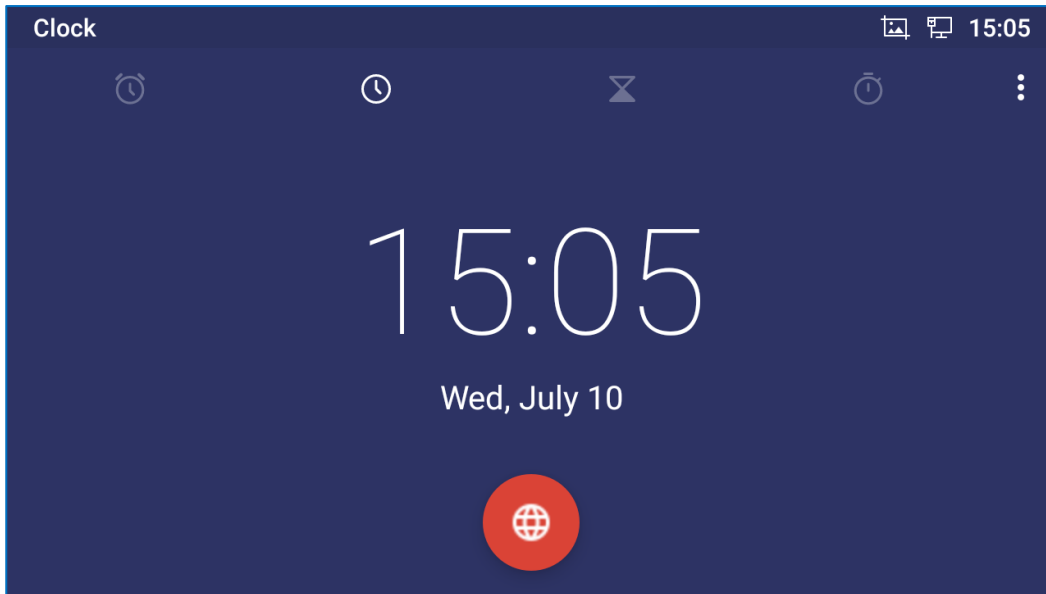

Figure 14: Open Clock Widget

- **Certain widgets such as the MPK Widget can be resized on the desktop.**

To resize a widget, press and hold the widget for about 2 seconds. Then lift your finger from the screen. This will bring up the white frame as shown in the following figure. Touch and drag the border of the frame to adjust the size.

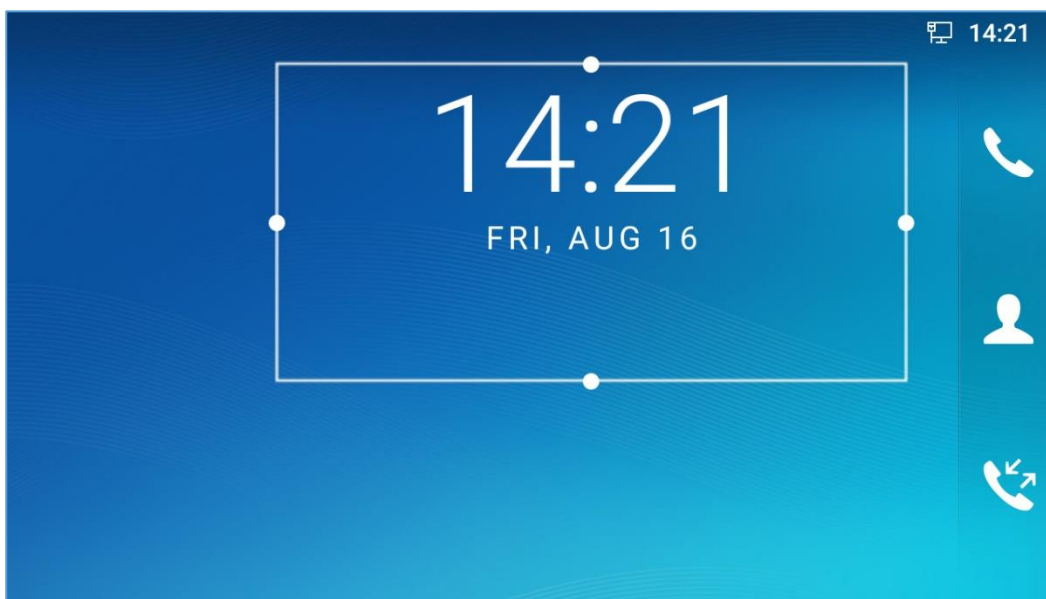

Figure 15: Resize Digital Clock Widget

- **Move/delete Application/Widget**

To move a shortcut/widget to a different spot on the desktop or to a different idle screen, touch and press the item for about 1 seconds until a recycle bin icon shows up on the top of the screen. Drag the

item up/down/left/right to the destination spot on the screen. Lift your finger once done. To delete the item/widget, press on it for about 1 seconds then move it to the recycle bin on the top of the screen.

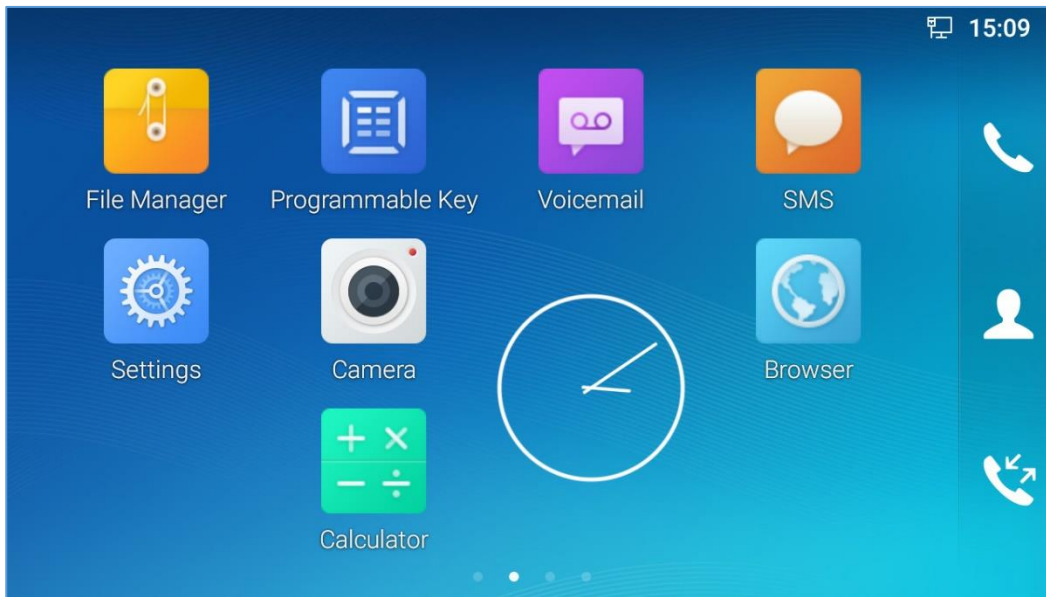



Figure 16: Move Clock Widget

Set Wallpapers

On the GXV3350 desktop, touch and press on an empty spot for about 2 seconds or users could press menu key  and select "Wallpaper" to set up the wallpaper for the desktop. Users could select wallpaper from different categories:

- **Local**
Open Gallery application and tap on the picture to preview. Touch and drag the picture to adjust the frame that will be used as wallpaper. Then tap on "Set Wallpaper" to set the selected area of the picture as wallpaper.
- **Wallpapers**
On the right side of the Wallpaper menu of the GXV3350. Select the picture from the default wallpapers available to preview and then tap on "Set wallpaper".

 **Note:**

Deleting an application icon will systematically pop up a window asking the permission to uninstall the application from the screen. Press ok to uninstall or press cancel to abort.

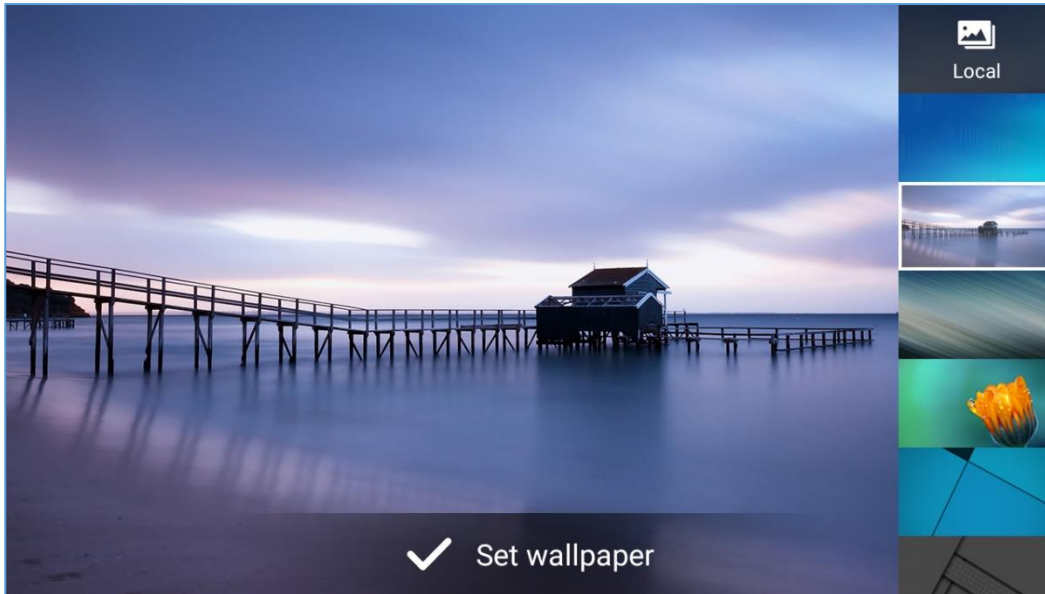



Figure 17: GXV3350 Choose Wallpaper

Manage Running Applications

On the GXV3350 desktop, press an empty spot for about 2 seconds then select “Management” or select "Management" after pressing Menu button .

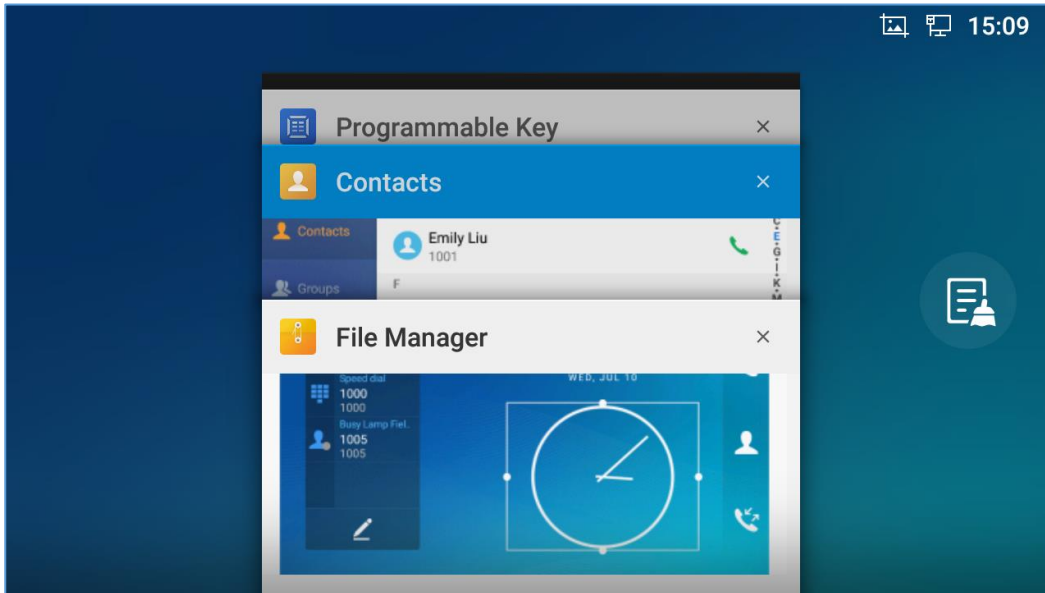



Figure 18: GXV3350 Recent Applications

Users could use the thread manager to do the following:

- Slide the running thread to the left or right to stop the application.
- Tap on icon  to delete all running threads.

- Tap on "Application" softkey to access application menu for advanced management options.

Idle Screen

Switch Idle Screens

The GXV3350 supports multiple idle screens by sliding the screen horizontally. On the GXV3350 screen, slightly touch an empty area and slide to the left or right using your finger to switch between different idle screens.

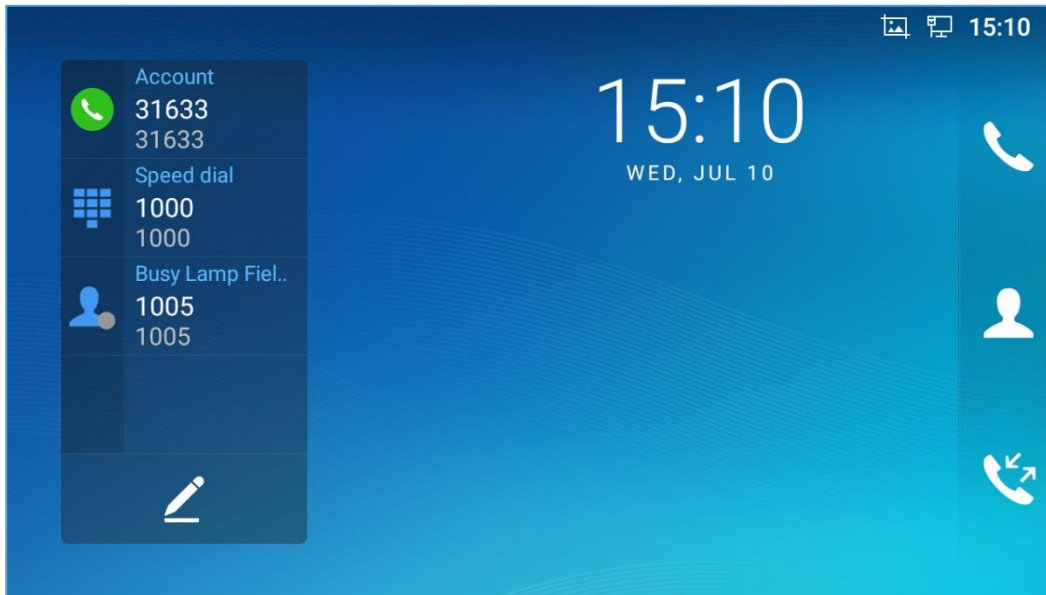





Figure 19: GXV3350 Switch Idle Screens

Set Up Idle Screen

- **Set home screen**

Follow the steps below to set up the HOME screen.

1. GXV3350 is up and running on idle screen.
2. Press the MENU button . This will zoom out all the screens as shown in **[Figure 20: Set up Home Idle Screen]**.
3. The screen with  displayed is the HOME screen. Others are shown with icon . Tap on the icon  to select the corresponding screen as the new HOME screen.

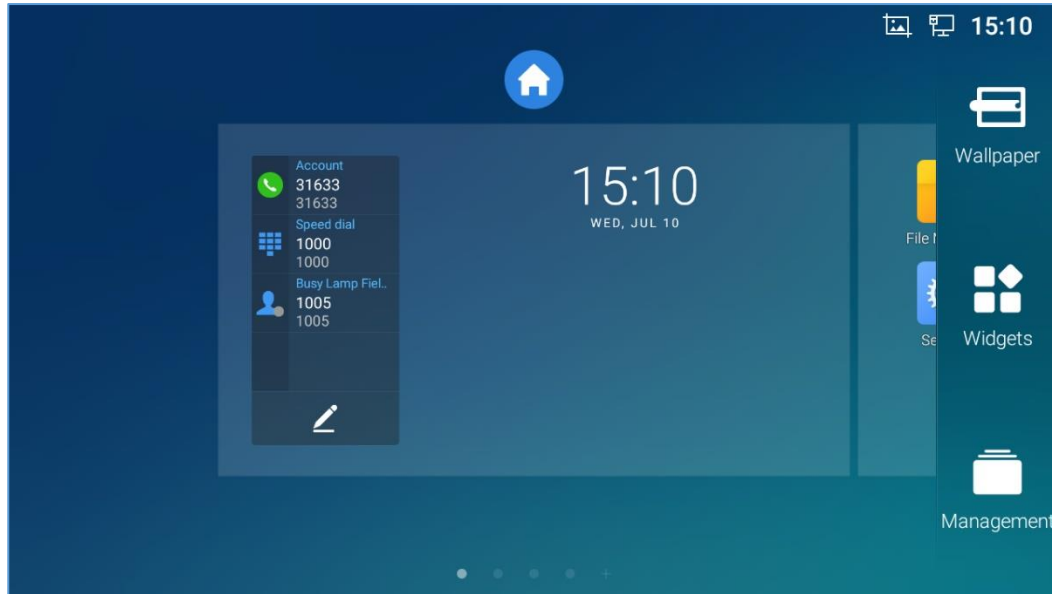



Figure 20: Set up Home Idle Screen

- **Add/Delete idle screen**

As shown in **[Figure 20: Set up Home Idle Screen]**, this section shows the available desktop screens. Users could add or delete idle screen.

➤ Add idle screen.

Tap on  to add a new idle screen.

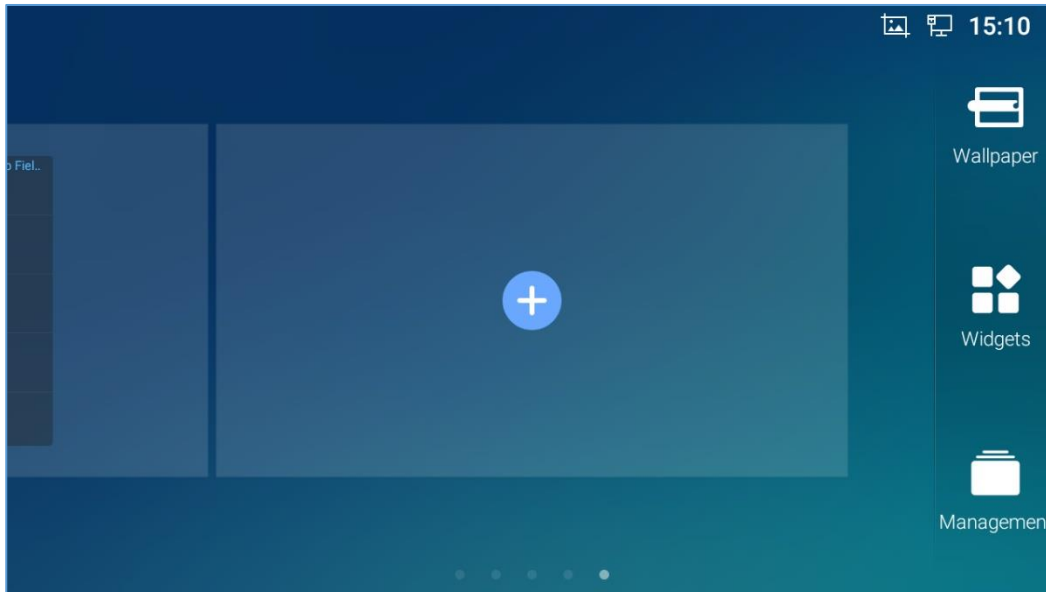



Figure 21: Add an Idle Screen

➤ Delete idle screen.

Tap on  to delete the Idle screen. Please make sure the apps, shortcuts or widgets on the idle

screen are removed first. Otherwise, the  icon won't show for the idle screen.

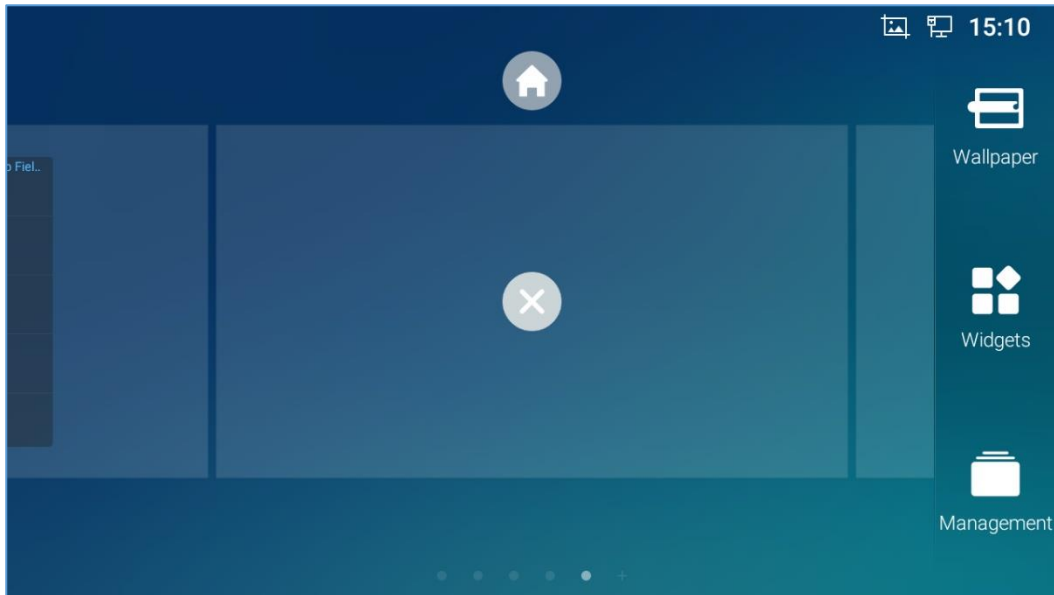

Figure 22: Delete an Idle Screen

Use the Status Bar

The status bar on the top of the GXV3350 screen provides visual notifications for the system settings and status, as well as quick access for important system settings. To access it, on the GXV3350 idle screen, slowly slide down from the top to the bottom of the screen as the following figure shows.

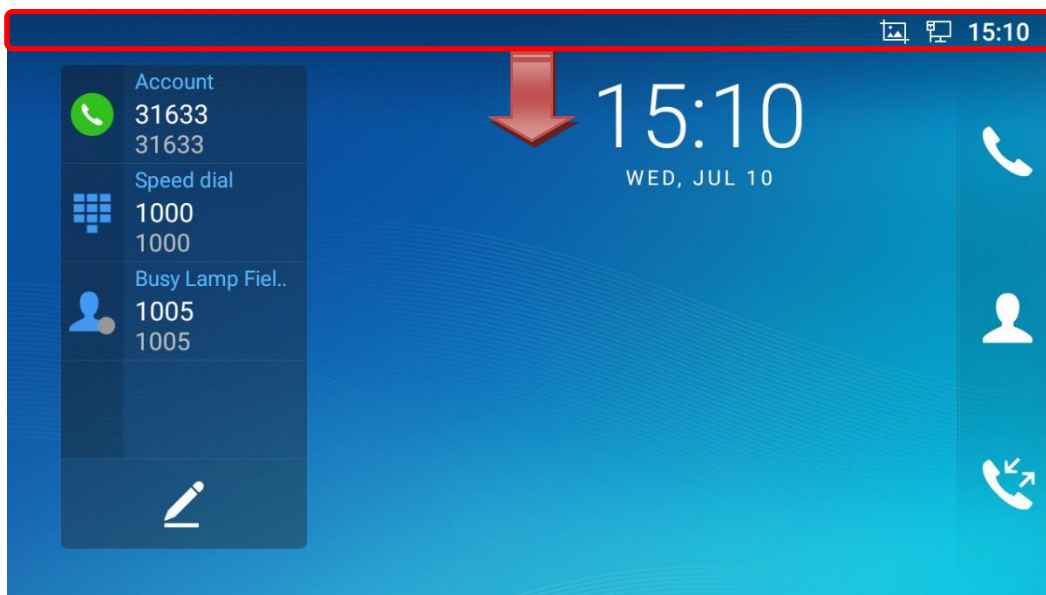

Figure 23: GXV3350 Top Status Bar

For more options on the Status Bar (call forward, RJ9 headset...) users can slip right the status bar.

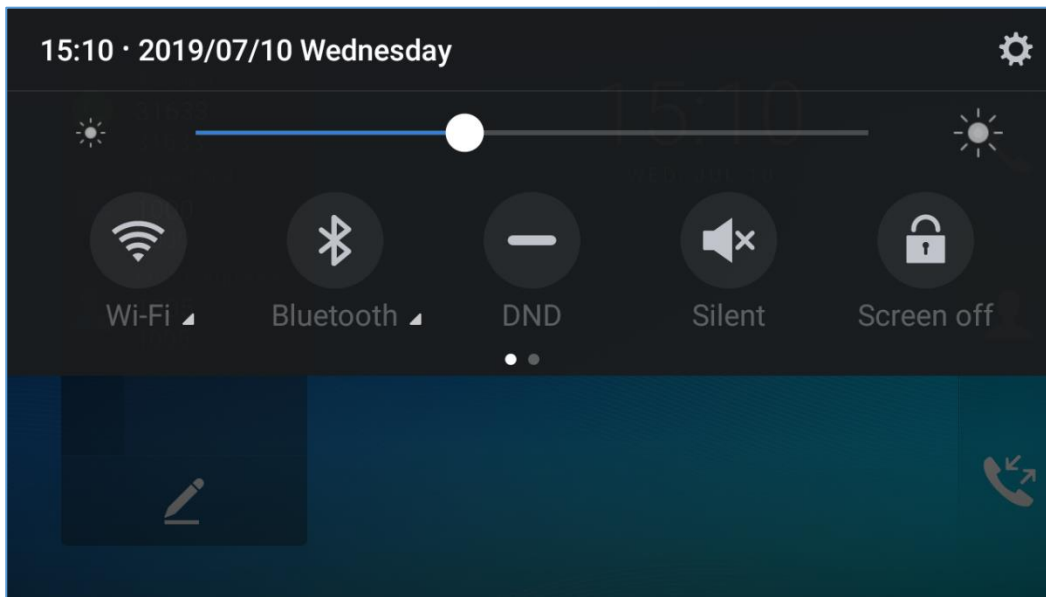

Figure 24: Status Bar - More Options

The running process and notifications will show up in the list. For example, the following figures indicate that there is a notification for an available Wi-Fi network.

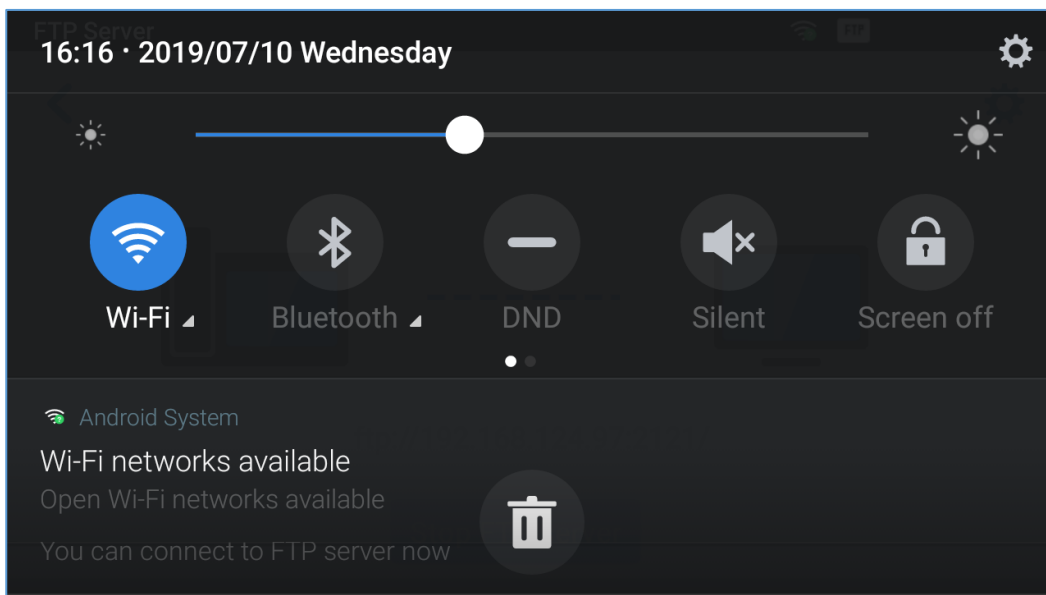

Figure 25: GXV3350 Top Status Bar – Notification

- Tap on the notification message to view the details.
- Slide the notification message to the left or the right side to remove it.

For more information about specific features in the notification bars, you can press the bottom right of the

feature in question.

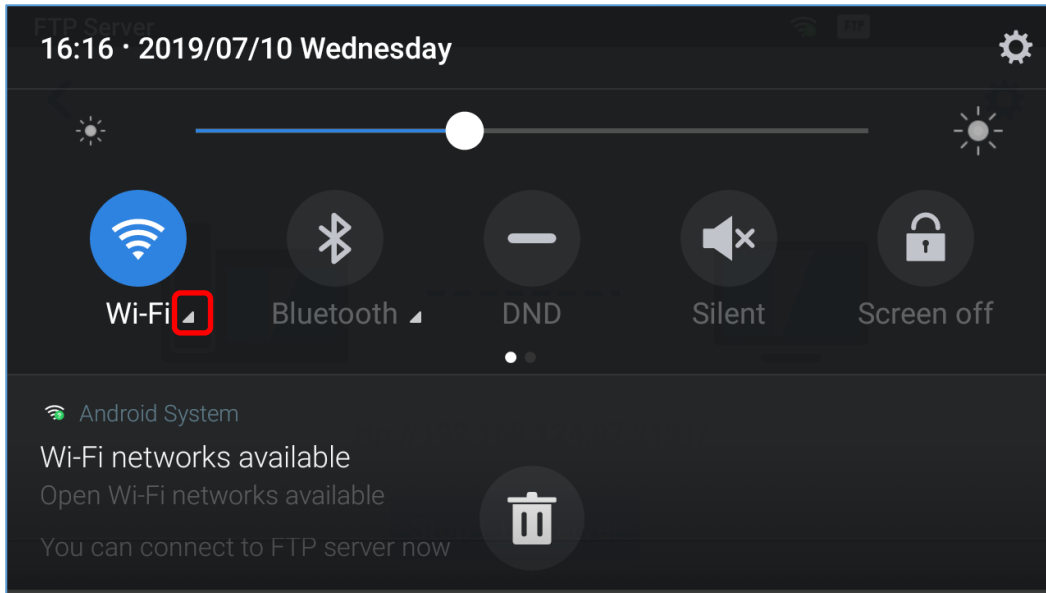

Figure 26: GXV3350 Top status Bar - Get more information

For example, you can see the available Wi-Fi Networks.

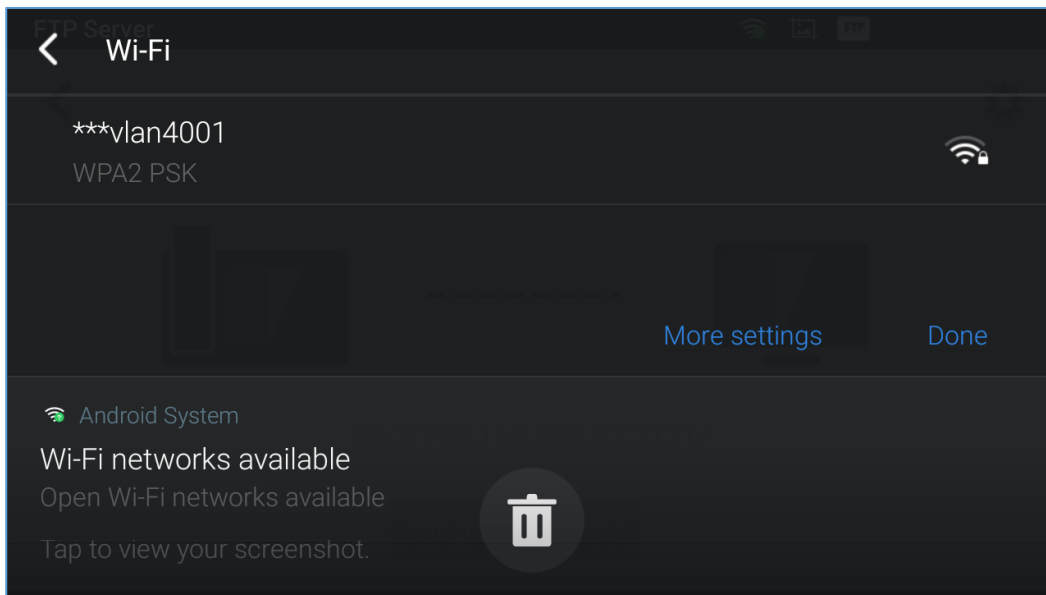































Figure 27: GXV3350 Top status Bar – Wi-Fi

Notifications in Status Bar

The following table describes the icons used on the status bar for notification purpose.

Table 7: GXV3350 Status Bar Notification Icons

	Network connected via Ethernet cable.
	Trying to connect to the network via Ethernet cable.
	Network disconnected via Ethernet cable.
	Handset is off hook.
	Speaker is being used. (x)
	RJ9 headset is connected.
	RJ9 headset is being used for calls.
	Wi-Fi is enabled and still not connected.
	Wi-Fi network is available.
	Wi-Fi is enabled and connected.
	Onscreen keyboard is activated.
	Bluetooth is enabled but not connected.
	Bluetooth is enabled and connected.
	Bluetooth headset is connected.
	Bluetooth headset is being used for calls.
	Downloading files via Bluetooth.
	Alarm is set up and enabled.

	DND is enabled.
	Silent mode is enabled. When it's on, the incoming call/message won't produce ring tone/notification tone from phone's speaker.
	USB flash drive is inserted.
	Downloading files via Internet connection.
	Unread voicemail to be retrieved.
	Incoming call from blacklist contact.
	Camera is disabled.
	Contact storage is full.
	HDMI cable is connected to display device.
	The phone is powered up using PoE.
	Call forward is set up.
	PPPoE is connected.
	PPPoE is not connected.
	Warning message.

System Settings in Status Bar

Slide down the top status bar and select **System Settings**. Users will see the following settings.

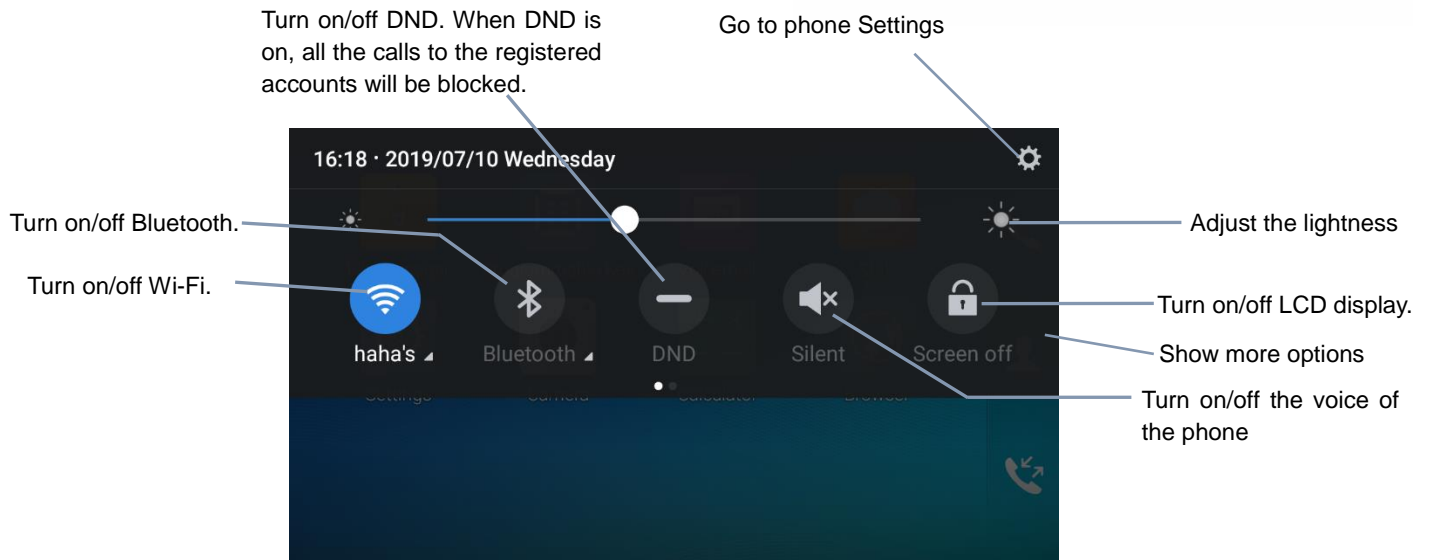

Figure 28: System Settings in Status Bar

Use the GXV3350 Keys

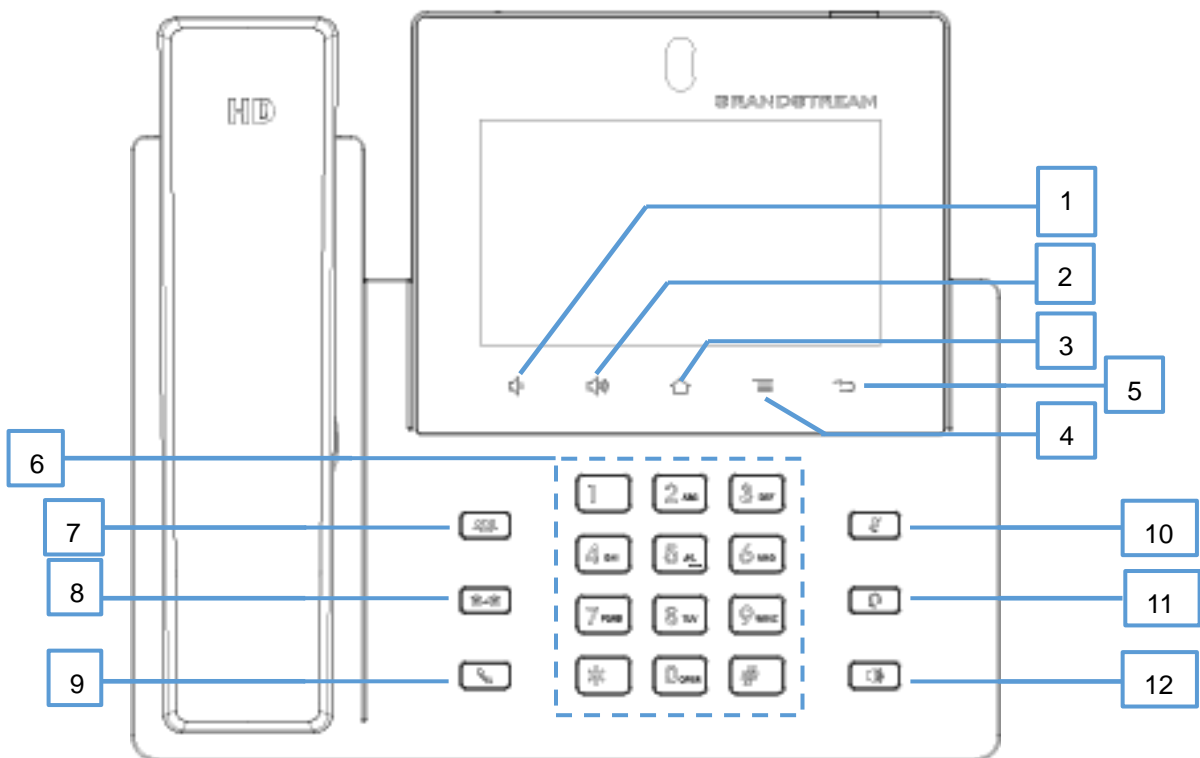

Figure 29: GXV3350 Keys

Table 8: GXV3350 Keys

1	Volume Down	Tap to turn down the call volume and media volume.
2	Volume Up	Tap to turn up the call volume and media volume.
3	Home	Tap to go back to Home screen; or touch and press for about 2 seconds to take a screenshot.
4	Menu	Tap to view options for different screens or applications.
5	Back	Tap to go back to the previous menu.
6	Keypad	Tap to enter numbers or send DTMF
7	Conference	Tap to enter into conference, then make an online meeting
8	Transfer	Transfer the call.
9	Dial/Send	Make a call or send DTMF.
10	Mute	Mute / Unmute the call. Or enable DND when free.
11	Earphone	Tap to enter into the dial interface or switch the media channel to earphone
12	Speaker	Tap to enter into the dial interface or switch the media channel to speaker

Keypad Shortcut Functions

The GXV3350 supports keys shortcuts for certain special system functions.

- **Screenshot**

Press and hold the Home button  for about 2 seconds to capture screenshot. The screenshot can be accessed via **File Manager**→ **Pictures**. The screenshot picture size is 1024x600 pixels.

- **Firmware upgrade via USB**

For users that could not use remote upgrade or could not access the phone's Web GUI to upload firmware, upgrading via external USB is an alternative. Follow the steps below to upgrade GXV3350 via USB.

1. Download the firmware file to PC and save it in USB.
2. Insert the USB to GXV3350.
3. Power cycle the GXV3350.
4. Wait for the LED in the upper right of the phone to light up in Green, then about 2 seconds later press the both keys “3” and “*” at the same time, it will go into the upgrading process.



5. The GXV3350 will start upgrading and display the upgrading process in the screen.
6. Wait until the upgrading is done.
7. The GXV3350 will reboot itself.
8. Check the firmware status and remove the USB.

- **Hard reset**

For users that want to factory reset the device manually, hard reset is an alternative:

1. Power cycle the GXV3350.
2. Wait for the LED in the upper right of the phone to light up in Green, then about 2 seconds, press the both keys “1” and “9” at the same time, it will go into the factory reset process.
3. The LCD screen will display “Factory reset, please wait”.
4. The GXV3350 will reboot with factory default settings.

Use the On-Screen Keyboard

The GXV3350 onscreen keyboard can be activated by tapping on an input field.

- **English Keyboard**

This is the default keyboard on GXV3350.

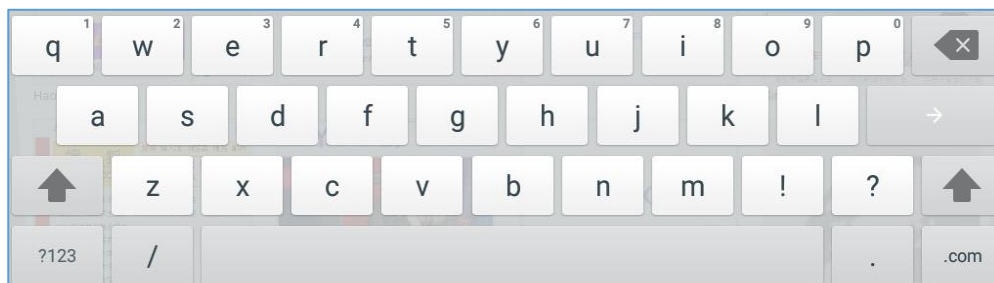

Figure 30: GXV3350 Onscreen Keyboard - English Keyboard

To switch input between lowercase and uppercase, tap on  (lowercase) or  (uppercase).

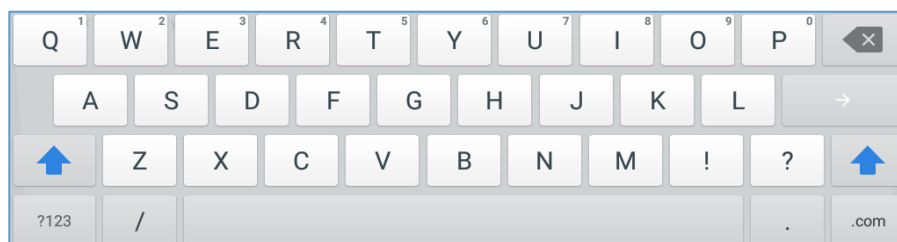

Figure 31: GXV3350 Onscreen Keyboard - Lowercase and Uppercase

- **Number and symbols**

To input number and symbols, tap  on the default keyboard to switch to number/symbols. Tap on

ABC to switch back.

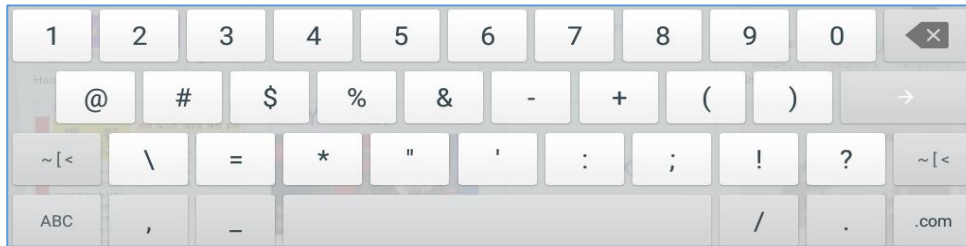

Figure 32: English Keyboard - Number and Symbols

Tap on **~[<** to access more symbols.

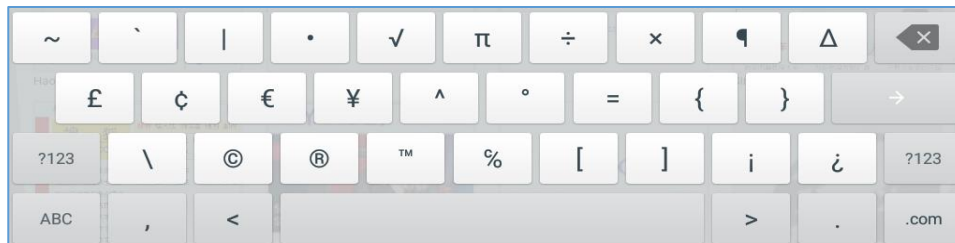

Figure 33: English Keyboard - More Symbols

 **Note:**







- To configure keyboard and input methods options, please refer to the following steps:
 1. Go to **Settings→Basic→Language & Keyboard→Virtual Keyboard**
 2. Click on “+” to add more input method.
 3. Go to **Settings→Language & Keyboard→Current Keyboard**, and choose from the input methods.
 4. After these steps, the method would change to the new one.

- Users could touch and press the key on the keyboard for about 2 seconds to input the alternative character. For example, touch and press the “+” key for about 2 seconds can get the selection “±”.

Use the Message Waiting Indicator

The GXV3350 message waiting indicator LED is on the upper right corner of the device. It could notify the users with different messages and status of the phone. Please refer to the status description below. **The priority for the LED indicator is from high to low in the following table.**

Table 9: GXV3350 MWI LED Status

Color	LED Status	Description
	Fast Flashing	Incoming call
	Solid	Calling, Talking, Conferencing, Screensaver on when the LCD is off
	Slow Flashing	A call is on hold
	Flashing	Missed call (s), New voicemail (s), New SIP Message (s)
	Solid	High memory usage, Maximum contact storage, Network disconnect
	Fast Flashing	Upgrading
OFF	OFF	Normal

MAKE PHONE CALLS

Register SIP Accounts

The GXV3350 supports up to 16 independent SIP accounts. Each account can have separate SIP servers, usernames and NAT configurations.

Account Status

On the idle screen, the account widget shows the account name, and registration status.

- The following figure shows the account is successfully registered (account icon is green).
- If the account icon is grey, it's still trying to register or unable to register.

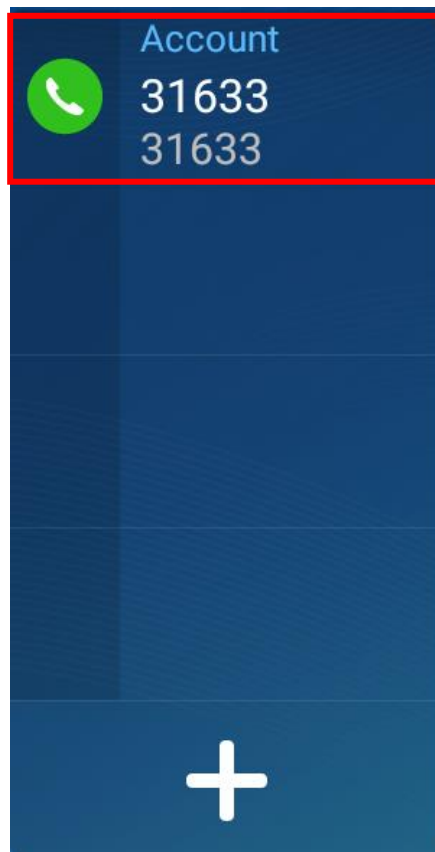

Figure 34: GXV3350 Account Widget

Configure SIP Account

To register a SIP account, users can access phone's LCD menu → **Settings** → **Advanced** → **Account Settings**

Or users could log in the GXV3350 web GUI → **Account** page to fill in the necessary registration information, i.e., Account active, Account name, SIP Server, SIP User ID, SIP Authentic ID, SIP Authentic Password, etc. Once the correct information is entered and saved, the account registration status will show on the main screen.



Note:

For web GUI login and configuration information, please refer to GXV3350 Administration Guide.

If the account is successfully registered, users could use one of the following ways to bring up dial screen to start making calls.

- Take the handset off hook.
- Select an account from the account widget in the idle screen.
- On the shortcut's menu of the idle screen, tap on  icon to open dial screen.

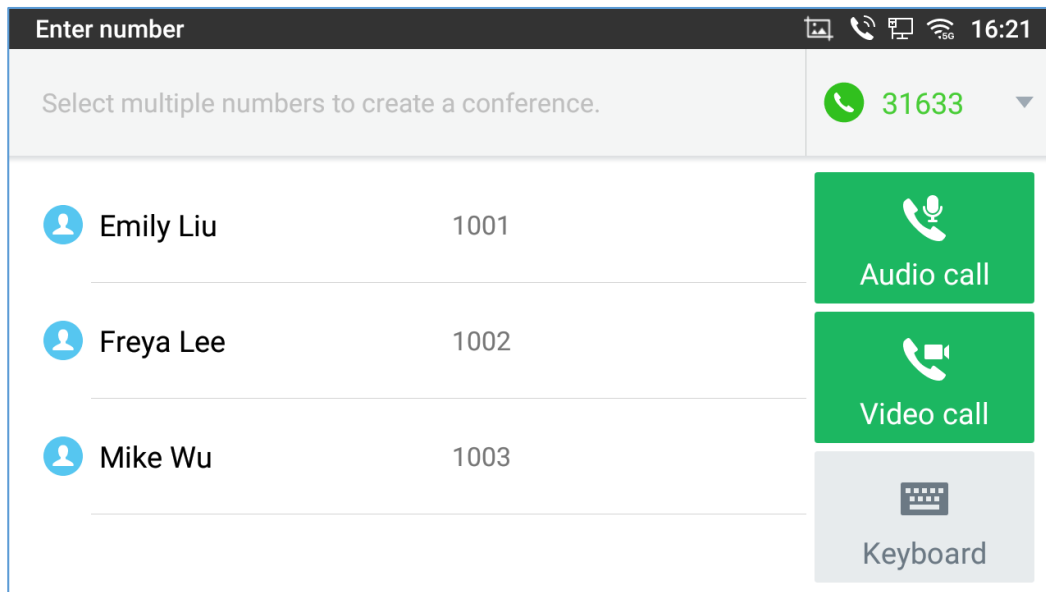

Figure 35: GXV3350 Dial Screen

If **Enable Video Call** option is disabled, the **Video Call** option on GXV3350 dial screen won't be available

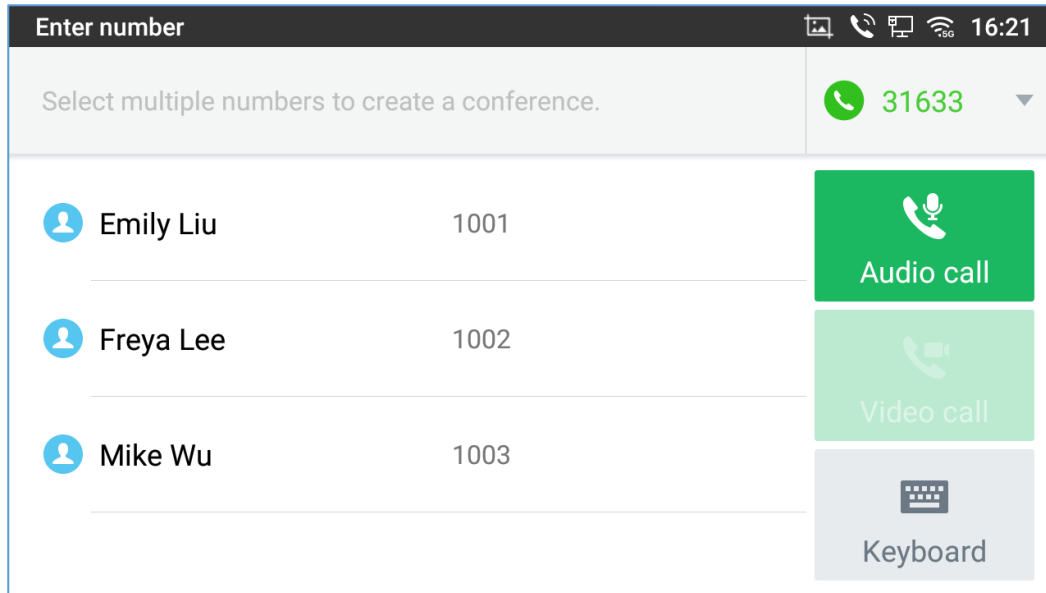



Figure 36: Disable Video Call Feature on Dial Screen

Dial a Number Directly

1. Use the methods mentioned above to open dial screen **[Figure 35: GXV3350 Dial Screen]**.
2. Select the account to dial out on the left panel of the dial screen. The selected account will be displayed in green
3. Choose the call mode to be used (call, paging or IP call), the call mode used will be displayed under the account.
4. Enter the digits to be dialed out using the keypad. If the digit matches call history, a list of numbers will be displayed for users to select from.
5. Tap on  (audio call only) or  (video call) to send the number. If no key is pressed, by default the call will be automatically dialed out after 4 seconds timeout.

 **Note:**

- By default, the "No Key Entry Timeout" is 4 seconds, meaning if no key is pressed after entering a number, the call will be automatically sent out after the timeout. The timeout interval can be configured under web GUI→**Account**→**Call Settings**.
 - GXV3350 allows users to press # key as SEND key. This behavior can be disabled via option "Use # as Dial Key" under web GUI→**Account**→**Call Settings**.
 - GXV3350 allows users to press # key as REDIAL key. This behavior can be disabled via option "Use # as Redial Key" under Web GUI→**Account**→**Call Settings**.
 - When the user enters the digit on the dial screen, if there is digit matching call history, or contacts name/number, the drop-down list will show the numbers. For example, if "John" is saved in the contacts,
 - entering 5 (JKL) 6 (MNO) 4 (GHI) 6 (MNO) will show call log with 5646 as the first four digits, as well as John's number. Users could then directly select one of them from the list, instead of entering all the digits.
-



Redial

Users can dial out the last dialed number if there is dialed call log, using the same SIP account making the call last time.

1. Enter the dial screen.
2. A list of dialed calls will be displayed on the left side of the dial pad. Tap on the number you would like to call, the number will be added to the dialing field, press Audio call or Video call to redial.

Dial a Number via Contact

Follow the steps below to dial a number via Contact.

1. Access Contacts by tapping on  icon on the left side of the idle screen.
2. Navigate in the contacts entries by sliding up/down on the screen.
3. Tap on the dial icon for the contact  .



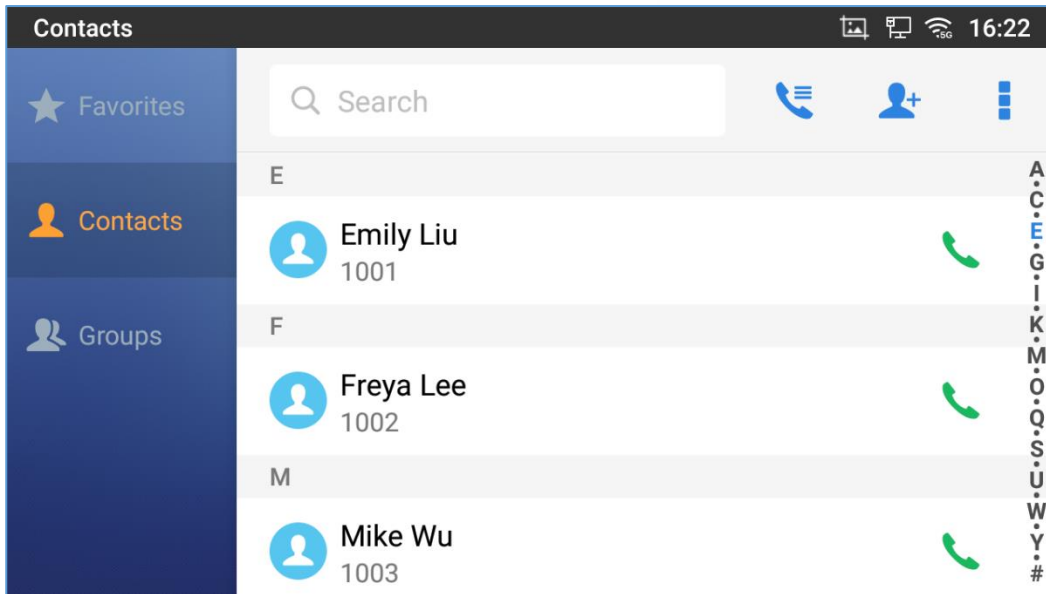



Figure 37: GXV3350 View Contacts

Dial a Number via Call History

1. Access Call History by tapping on  icon on the bottom of the idle screen.
2. The LCD will display all call history types: "All", "Missed", "Outgoing" and "Incoming" calls.
3. Navigate in the call history list by selecting the call history category and sliding up/down on the screen.
4. Tap on the entry to show more details or tap on  to dial out.

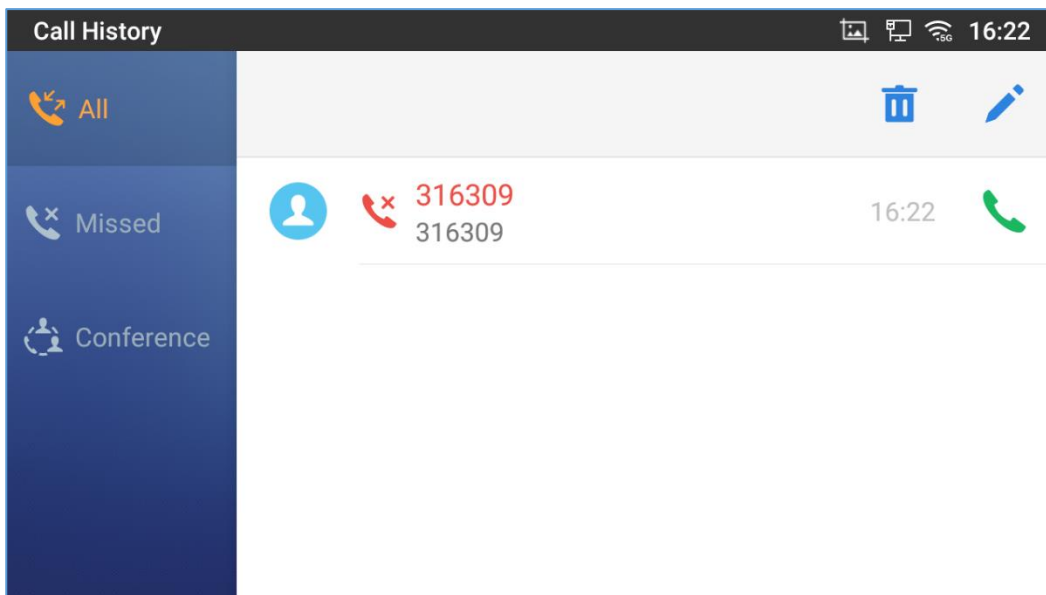



Figure 38: GXV3350 Call History

Direct IP Call

Direct IP Call allows two phones to talk to each other in an ad-hoc fashion without a SIP proxy. VoIP calls can be made between phones if:

- Both phones have public IP addresses, Or
- Both phones are on the same LAN/VPN using private or public IP addresses, Or
- Both phones can be connected through a router using public or private IP addresses (with necessary port forwarding or DMZ).

To make a direct IP call, please follow the steps below:

1. Directly enter the 192*168*xxx*xxx through the Number Buttons in the idle screen to bring up dial screen on GXV3350.
2. Set the call mode as "IP Call".
3. Input the target IP address. For example, if the target IP address is 192.168.0.116 and the port is 5062 (i.e., 192.168.0.116:5062), input the following:
192*168*0*116#5062. The * key represents the dot (.) and the # key represents the colon (:).
4. Press on  (audio call only) or  (video call) to dial.

Answer a Call

Single Incoming Call

- When the phone is in idle and there is an incoming audio call, the phone will show the call screen as below. Tap on "Answer" softkey to answer the call via speaker or pick up the handset the answer the call.

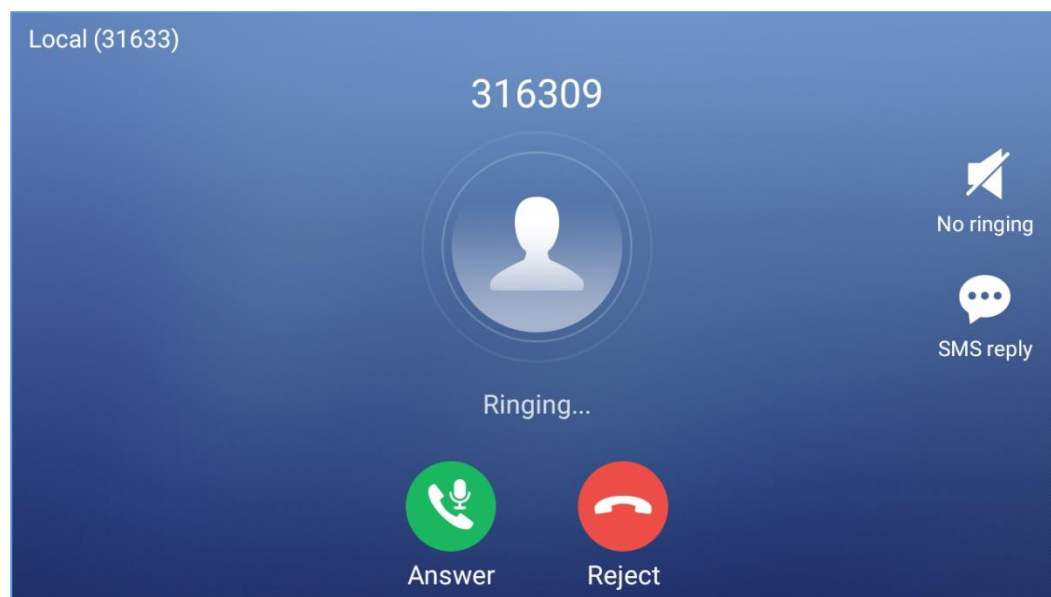

Figure 39: Single Incoming Call – Audio

- When the phone is in idle and there is an incoming video call, the phone will show the call screen as below. To answer the call with audio only, tap on "Audio" to answer the call via speaker. To answer the call with both audio and video, tap on "Video". During video call or pick up the handset, the audio will switch to handset if picking up the handset.

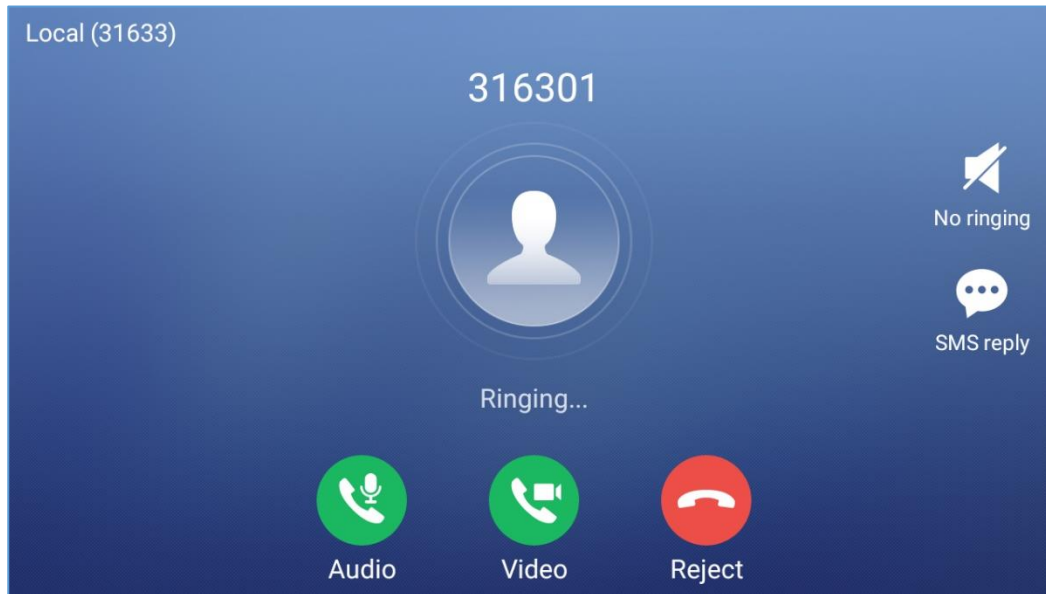

Figure 40: Single Incoming Call – Video

Note: Users could select the **Video Display Mode** on phone's Web UI→**Phone Settings**→**Video Settings**. Set the video display mode to "**Original proportion**", "**Cut proportionally**" or "**Add black margin proportionally**".

If set to "**Original proportion**", the phone displays video in its original proportion. If the video display proportion is different from the one on the phone, the phone will stretch or compress video to display it. If set to "**Cut proportionally**", the phone will cut video to meet its own display proportion. If set to "**Add black margin proportionally**", the phone will display video in its original proportion, if still exists spare space, the phone will add black edge on it.

Preview Function for Incoming Call

- If the phone set the "Preview" feature for the incoming call from Web UI, the phone will display one more key "Preview" when there is an incoming video call. End users will preview the remote end without answering the video call. After previewing, end user can tap on Answer key to answer the video call, or "Reject" key to reject it. This feature should be supported by the SIP server. Please contact service provider for more information.

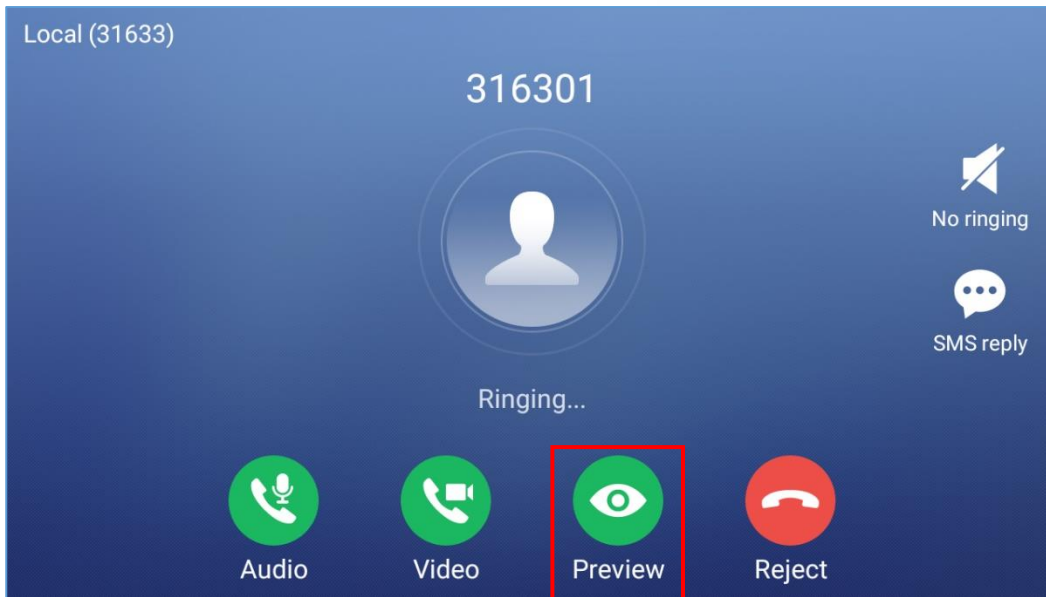

Figure 41: Single Incoming Call – Preview-1

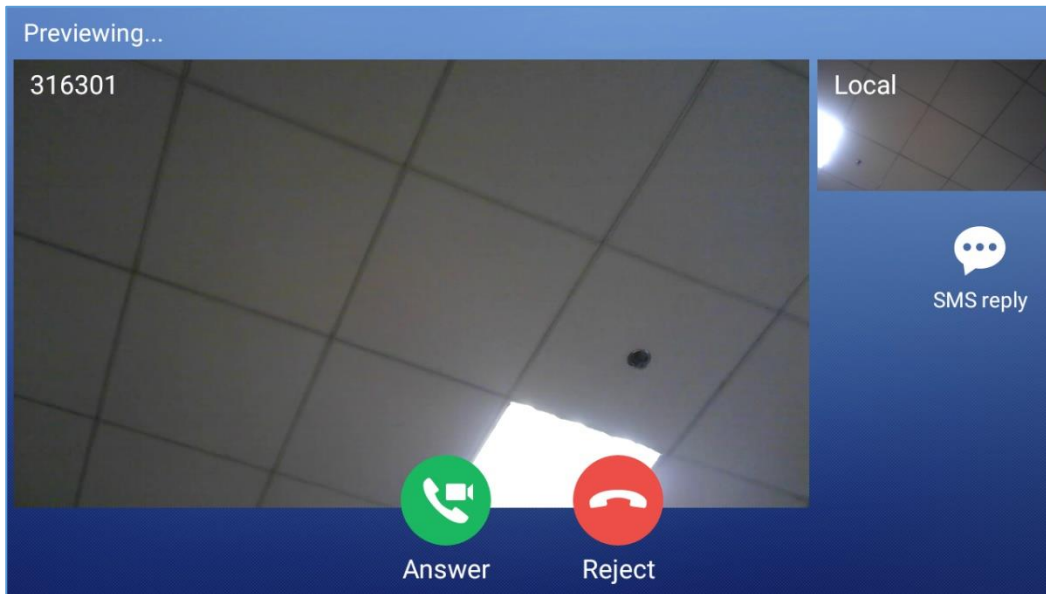

Figure 42: Single Incoming Call – Preview-2

Transfer Function for Incoming Call

- If the phone set the “Transfer” feature for the incoming call from Web UI, the phone will display one more key “Transfer” when there is an incoming call. End users will have the possibility to transfer the call without answering. After pressing “Transfer” button, end user can enter manually destination or press “MPK” to select a destination. “Reject” key to reject it. This feature should be supported by the SIP server. Please contact service provider for more information.

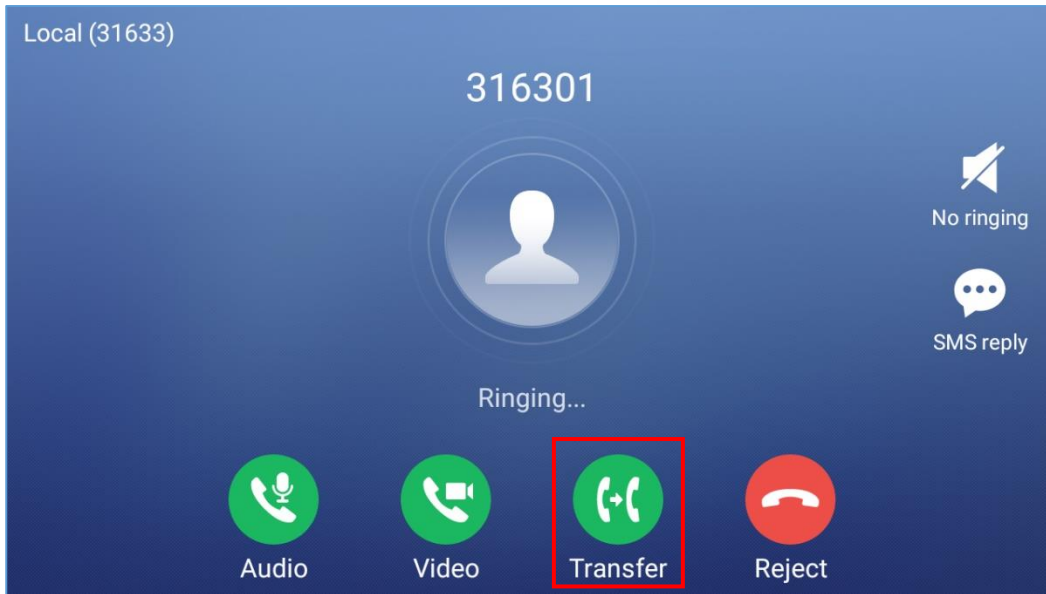

Figure 43: Single Incoming Call – Transfer-1

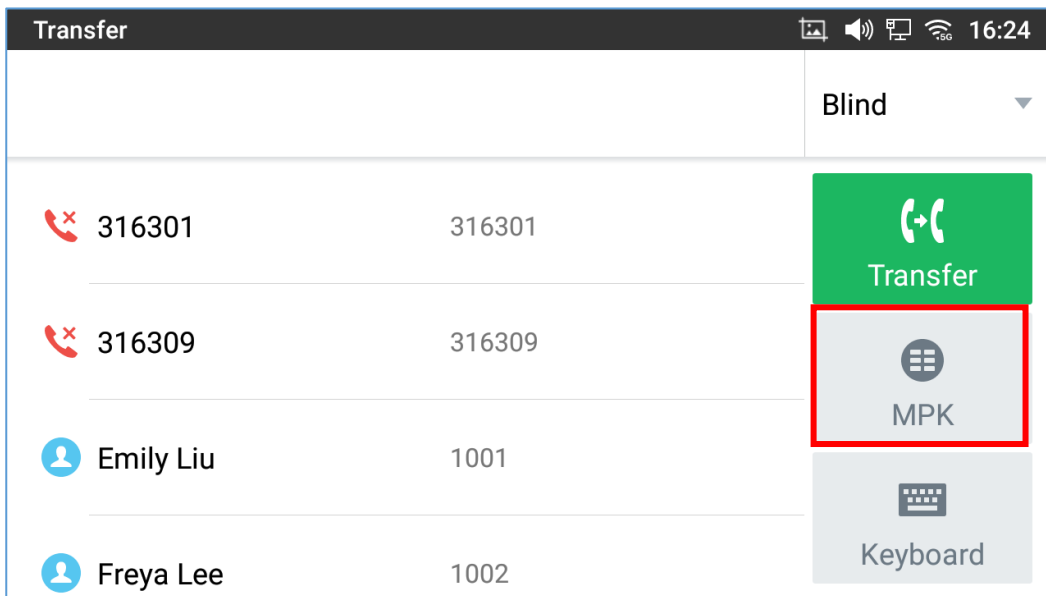

Figure 44: Single Incoming Call – Transfer-2

Multiple Calls/Call Waiting

1. When there is another incoming call during active call, users will hear a call waiting tone, with the LCD displaying the caller name and ID for the incoming call. In the prompt window, it shows new incoming call from "316307" with the caller number; the account bar in purple is the current active call with "316307".

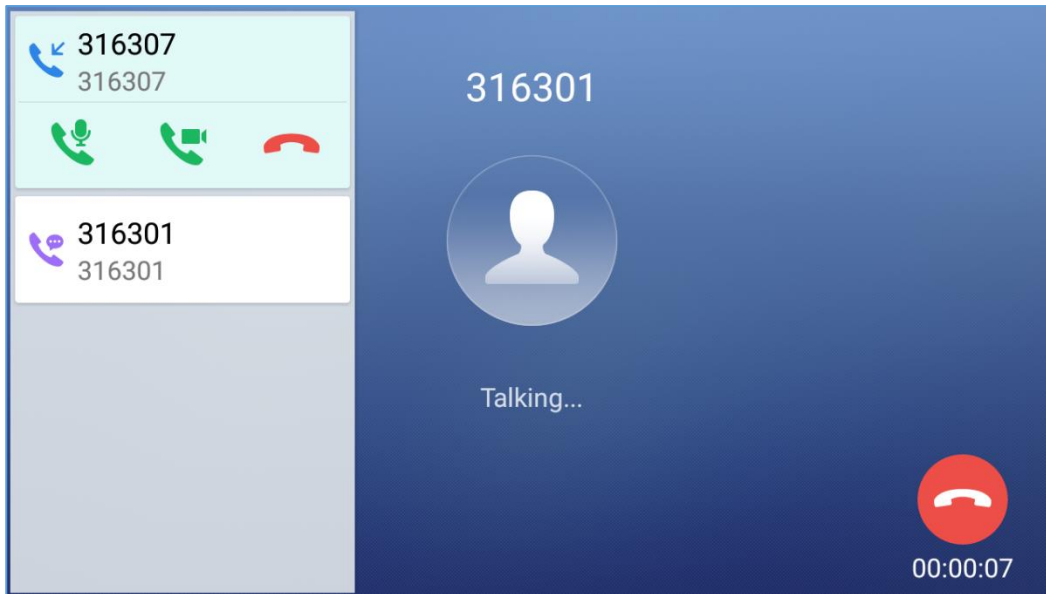

Figure 45: Call Waiting

2. Similar to single incoming call, if the incoming call is video call, users can choose to “Audio Answer” or to “Video Answer” to answer the call.
3. Once the new call is answered, the current active call will be placed on hold. If the new call is rejected by tapping on "Reject" softkey, the current active call will not be interrupted.

Call Progress Status

During an active call if Home Button is pressed, the phone will go back to the home screen and the call-in-progress status will be shown on the GXV3350 status bar, once clicking the bar it will go back to call screen.

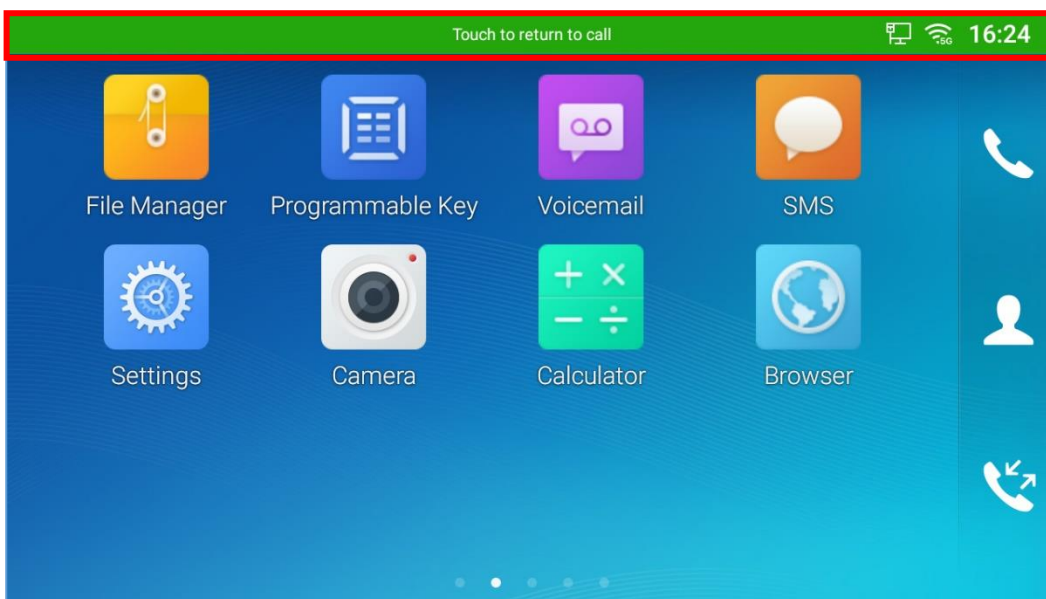

Figure 46: Touch to Return to Call Screen

Call Hold

During the active call, press HOLD softkey. The LCD screen will show as below. To resume the call, press UNHOLD softkey on the bottom of the screen.

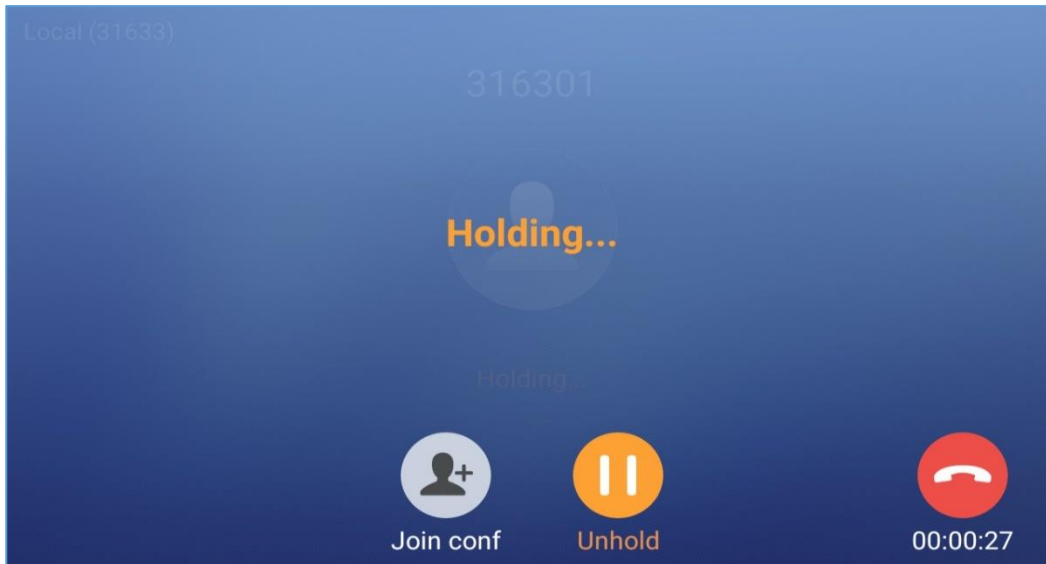

Figure 47: Call on Hold

Call Recording

1. During the call, users could record the conversation to the phone by tapping on “Record”
2. If need to stop the recording, tap on “Stop Recording”
3. The recording files can be retrieved from the GXV3350 Web GUI→Applications→Recording.

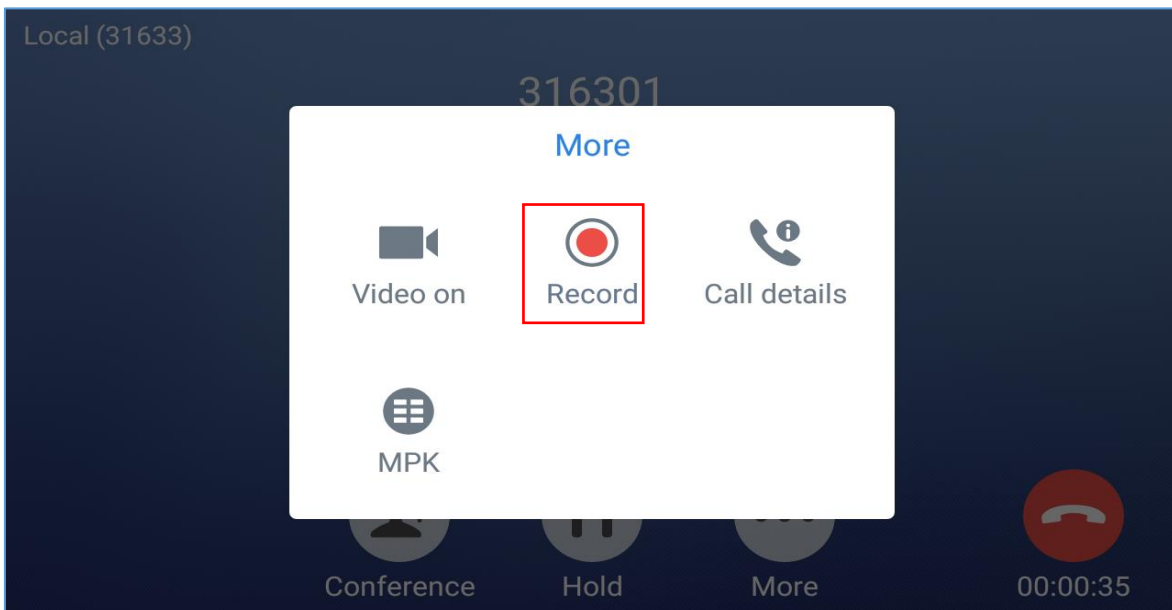

Figure 48: GXV3350 Call Recording

Note:

Users can configure the recording mode via Web GUI→Phone Settings→Call Settings→Record Mode.

Five modes are available:

- **Record Locally:** The phone will use the local recorder for call recording, and the audio file will be saved according to the recorder setup.
- **Record on PortaOne:** The phone will send the specified SIP messages to the corresponding server
- **Record on UCM:** The phone will send the recording feature code to the UCM server to request for recording, and the recording function will be executed by the server.
- **Record on BroadSoft:** The phone will send the recording feature code to the Broadsoft server to request for recording, and the recording function will be executed by the server.
- **Disable:** The phone cannot record in a call.

Users can configure the phone to Auto-Record all calls established via Web GUI→Phone Settings→Call Settings→Enable Auto Record When Call Established. But, if Record Mode is set to “Disable”, this option cannot be configured.

MPK Monitoring

During the call, users could view and monitor the programmable keys configured for the current Account:

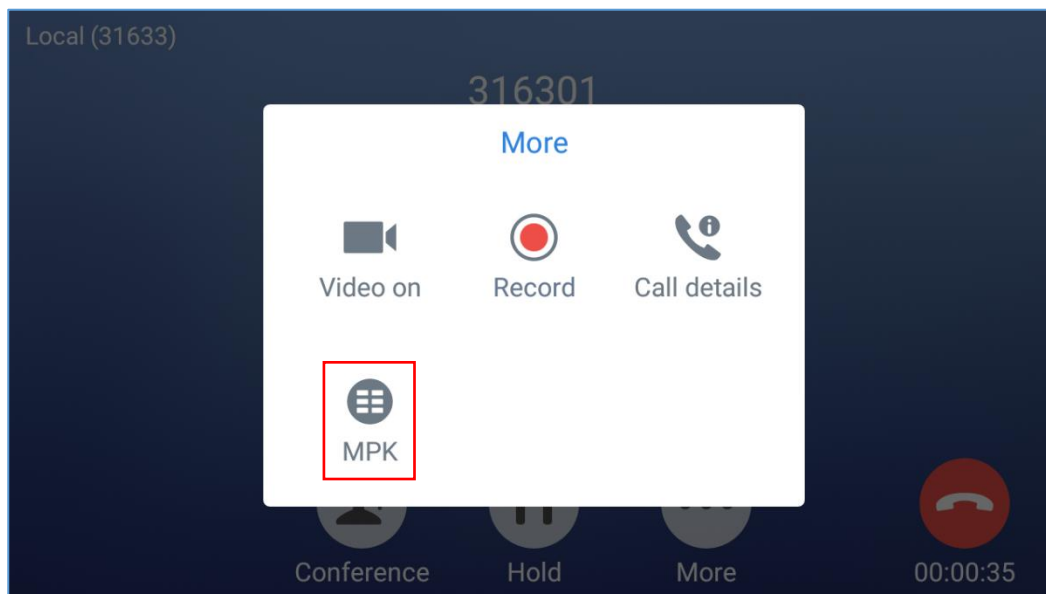

Figure 49: MPK button

1. During the Call, press the MPK button as shown above.
2. The list of MPK configured for the active account will be displayed.

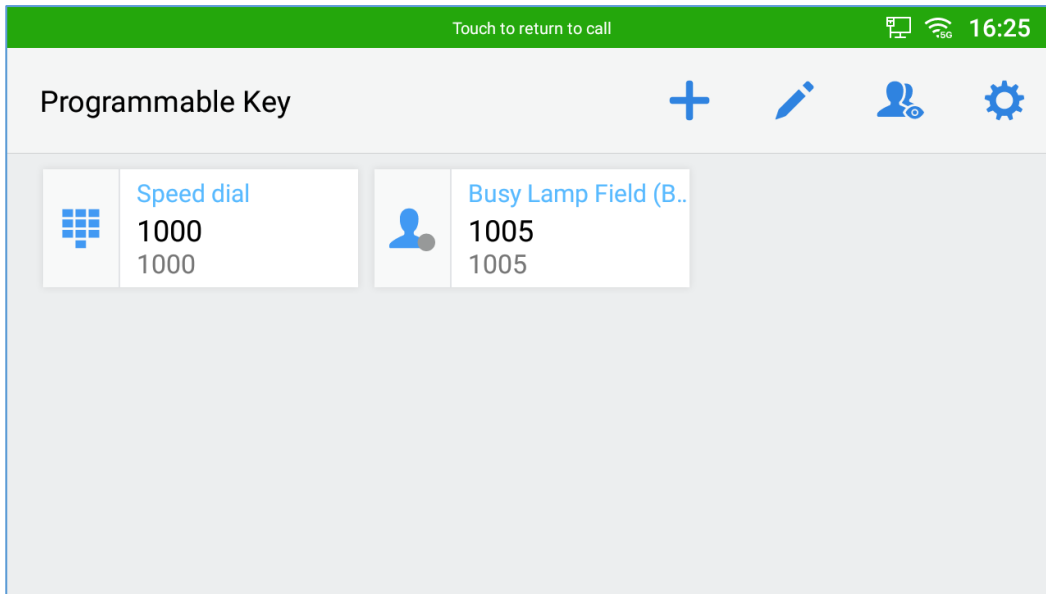



Figure 50: MPK list

3. User can choose an MPK from the list as they see convenient

Mute

During an active call, press “**Mute**” button to mute the call. The mute icon  will be displayed behind the local number on the top of left of the screen. Press “**Mute**” button again to unmute the call.

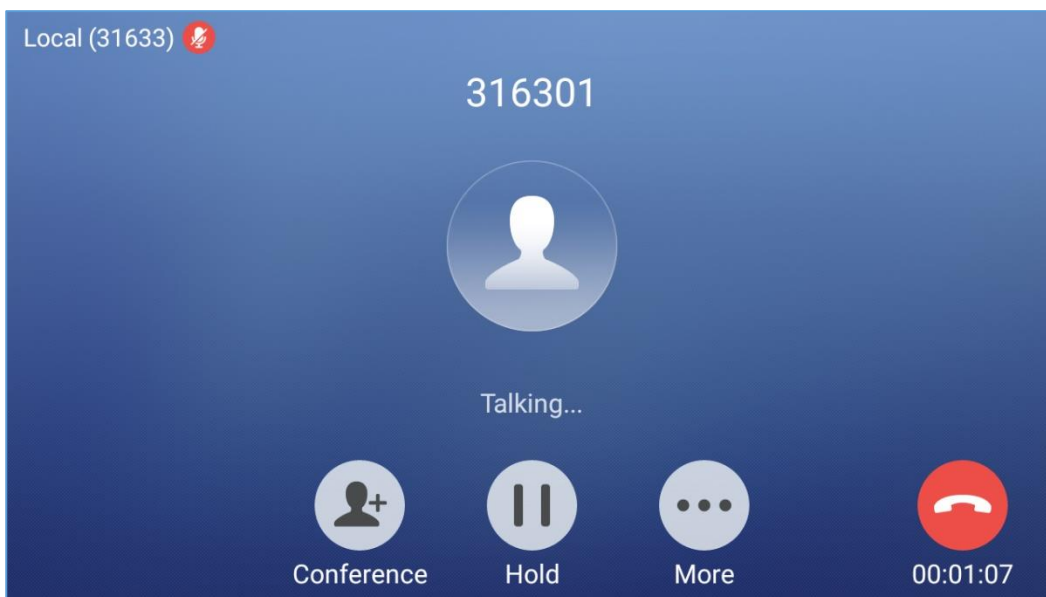

Figure 51: GXV3350 Call Mute

Turn on Video during Audio Call

Users could establish audio call first and then turn on video or accept video request during the call if the other party supports video call as well.

- **Turn on video during audio call**

During an active audio call, on the call screen, tap on "More" and select "Video On", a video request will be sent to the other party.

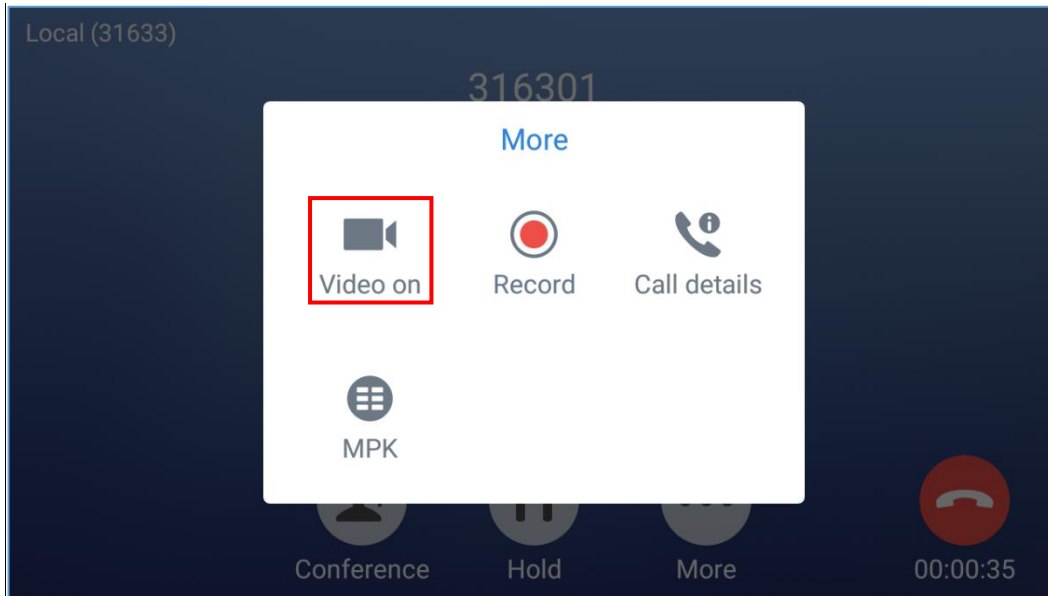

Figure 52: Turn on Video During Audio Call

- **Accept video request**

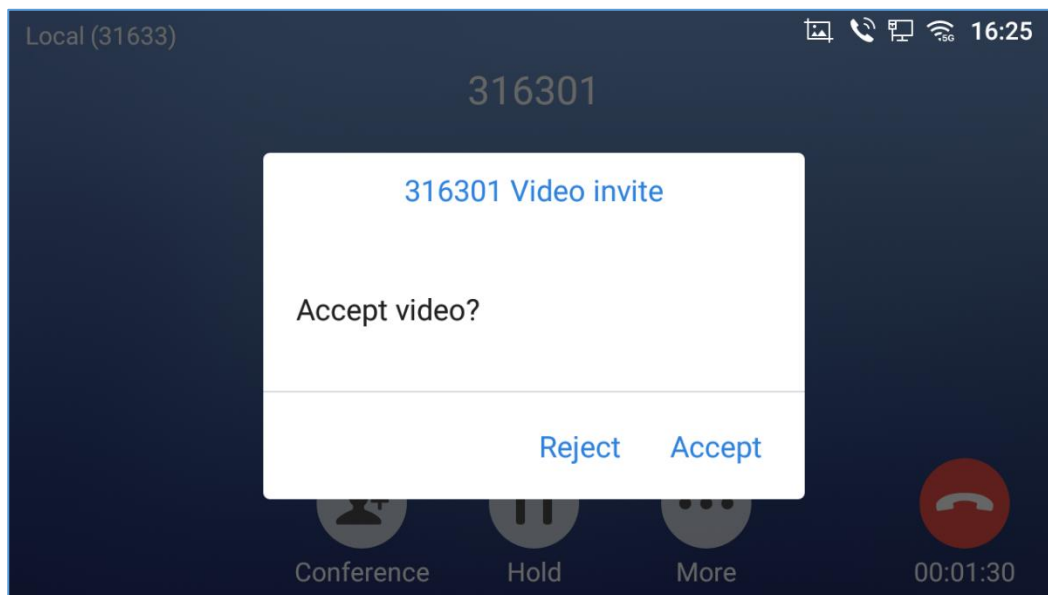

Figure 53: Accept Video During Audio Call

If the GXV3350 receives video request during the audio call, a message "Accept video?" will be prompted. Select "Accept" to establish video during the call. If the **Enable Video Call Feature** is not enabled on GXV3350, the "Video On" option on GXV3350 will be hidden during the audio call. However, if the GXV3350 receives video request during the audio call, users could tap to accept the video request.

Call Details during Call

During an active/video call, on the call screen, tap on "Mode" and select "Call details".

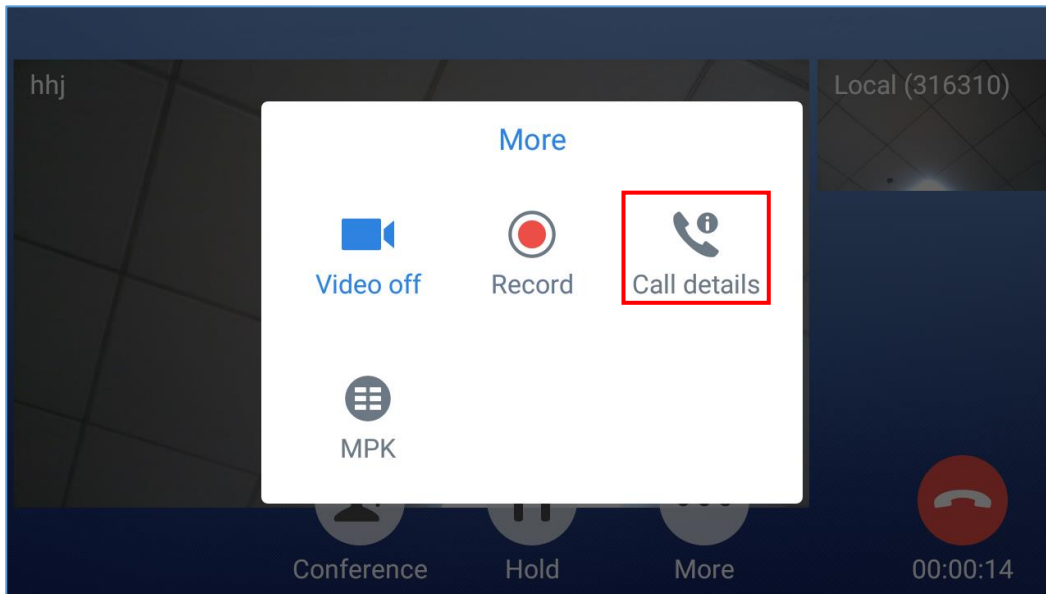

Figure 54: Select Call Details During Video Call

The call details for RTCP info report will be displayed as shown below.

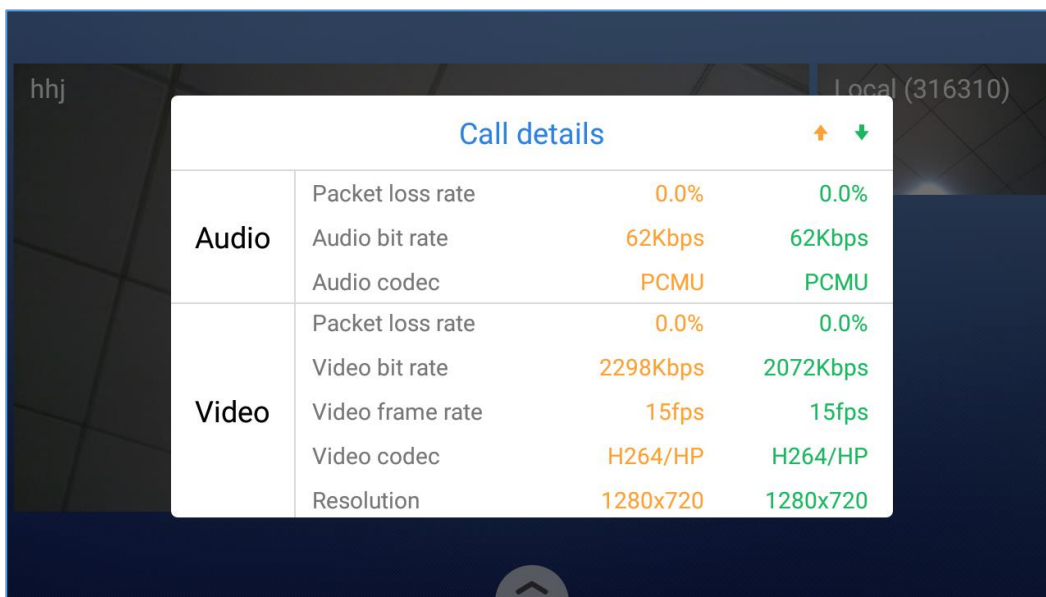

Figure 55: Call Details

Quick DTMF During Call

During an Audio/Video call, users have the ability to show DTMF buttons and each one of them can perform a different action. On the call screen, tap on “Mode” and select “Quick Dtmf”.

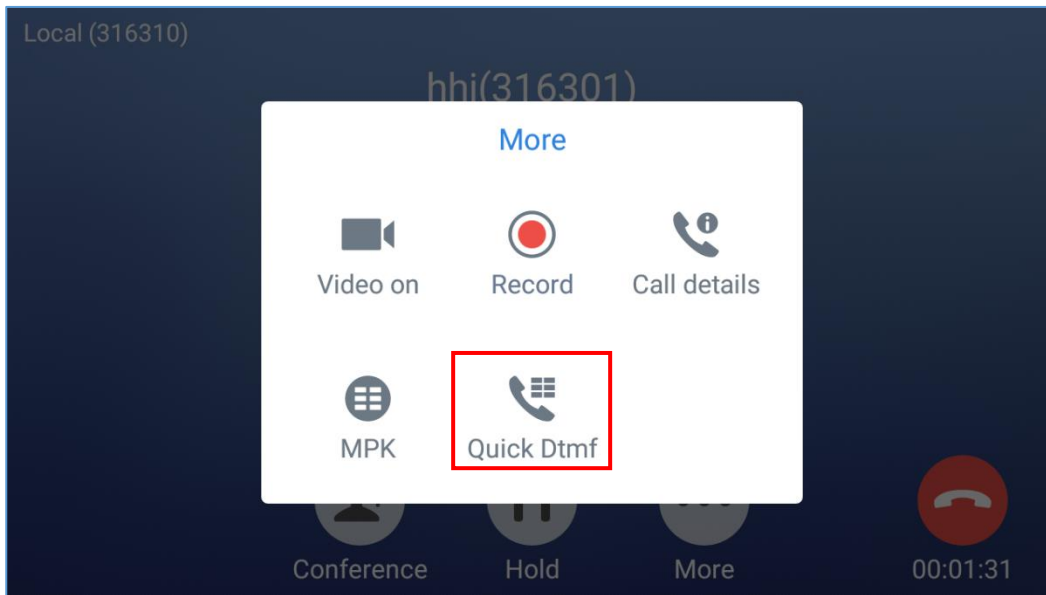

Figure 56: Select Quick DTMF During Call

This feature can be configured by following below steps:

1. Go to GXV3350 Web GUI→Value-added Service→Value-added Service.
2. Configure the service type as DTMF and specify its Display Name.
3. Set the DTMF content in “DTMF Content” field.
4. Repeat the same steps in order to get more DTMF Buttons displayed during the call. See the following figure.

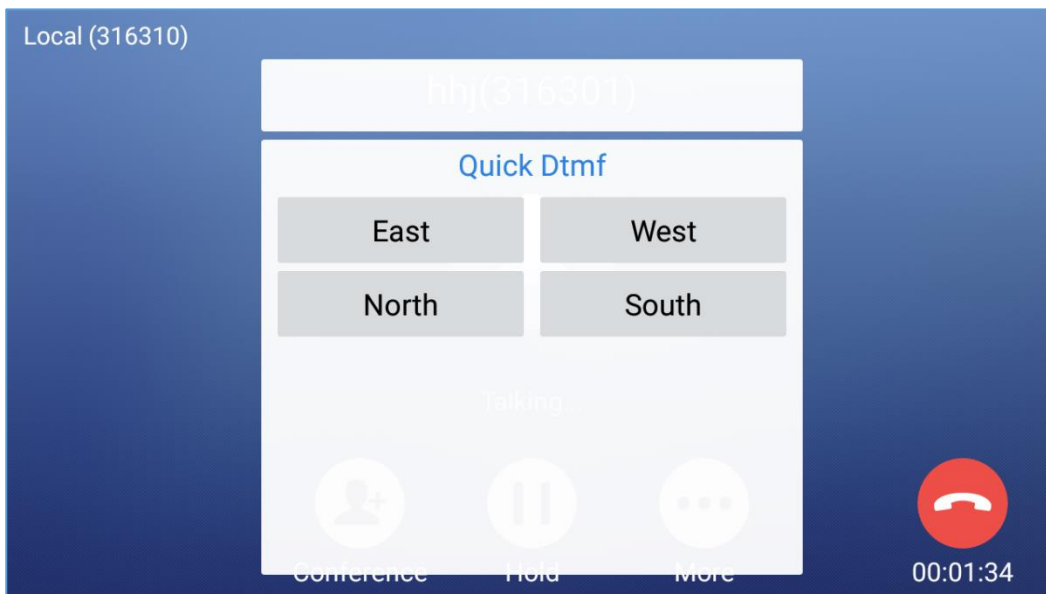

Figure 57: DTMF During Call

Switch Audio Channel During Call

- GXV3350 allows users to switch among handset, speaker or headset(RJ9 headset, Plantronics EHS headset and Bluetooth headset) when making calls. Onhook to switch to handset; press the Headset button to switch to headset; press the Speaker button to switch to speaker.
- If Bluetooth headset is connected, the audio will be automatically switched to Bluetooth headset once the call is established.
- The status bar on the top of the screen shows the current audio channel being used during the call. If pressing the corresponding key for the currently used audio channel, the call will be hang up.

Call Transfer

A call can be transferred to another party during the call. The GXV3350 supports blind transfer and attended transfer.

Blind Transfer

1. During the active call, tap on "Transfer" button.
2. Select "Transfer" to bring up the transfer screen.
3. Select transfer mode as "Blind" by tapping on the highlight area [Figure 58: Blind Transfer].The default transfer mode is "Blind".
4. Enter the digits.
5. Tap on "Transfer" softkey.
6. The call will be transferred and GXV3350 will hang up the call.

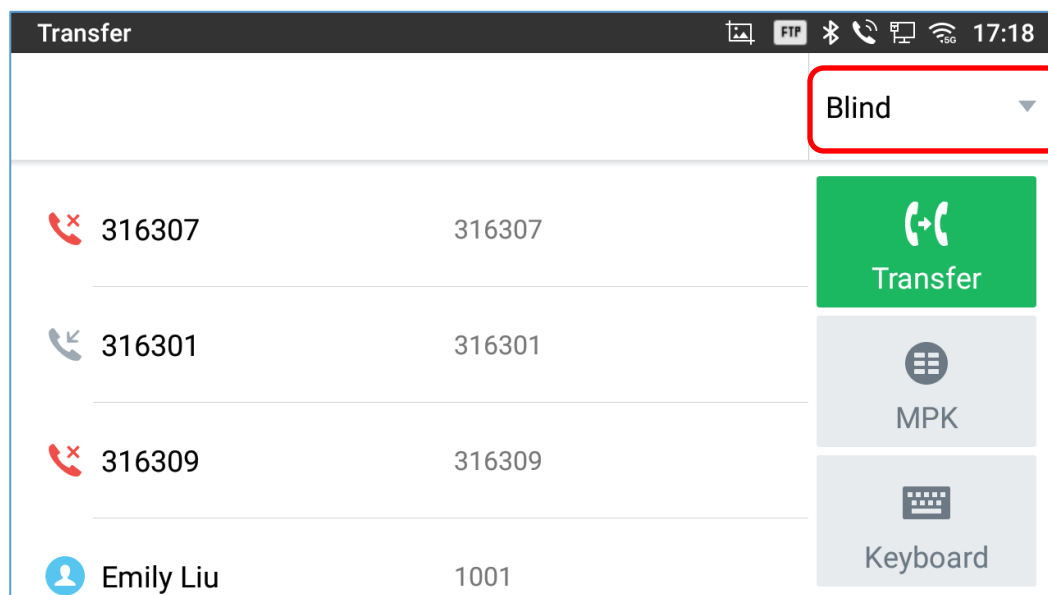



Figure 58: Blind Transfer

Note:

- If wrong digits are entered, tap on  to delete the digit one by one;
- If users would like to cancel the transfer, press  button to go back to the previous talking screen.

Attended Transfer

GXV3350 supports attended transfer:

1. During the active call, tap on "**Transfer**" button to bring up transfer screen.
2. Select transfer mode as "Attended" by tapping on the mode selection area (see figure below).

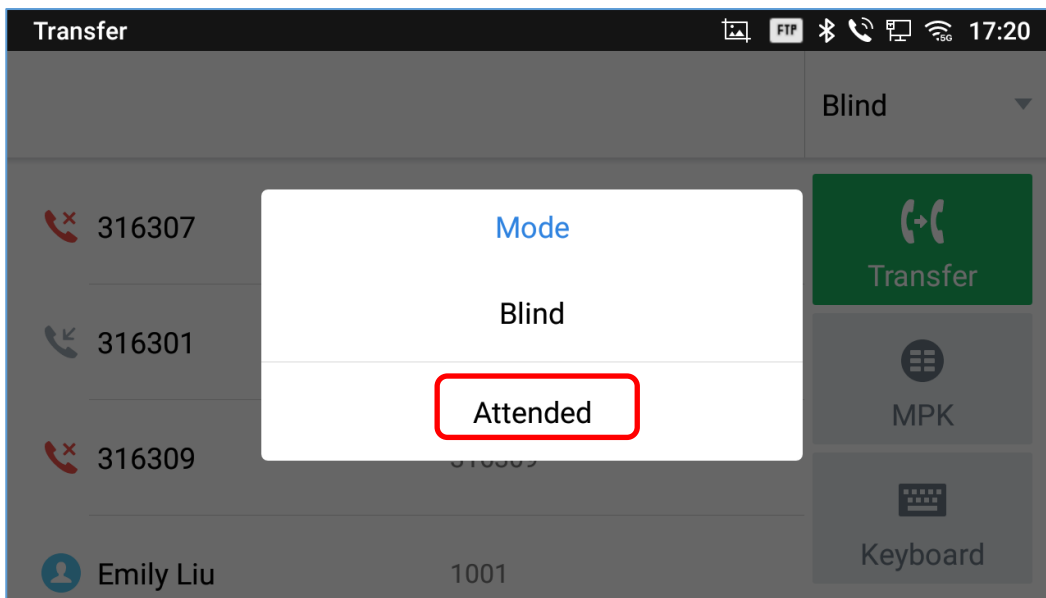

Figure 59: Attended Transfer

3. Enter the transfer target number, and then press the "Transfer" soft key on the right.
4. Before transfer target answers the call, GXV3350 hears the ringback tone, and the touch screen prompts shown as below. Users could tap on "Cancel" to cancel the transfer, tap on "End" or simply hang up the call to complete call transfer.

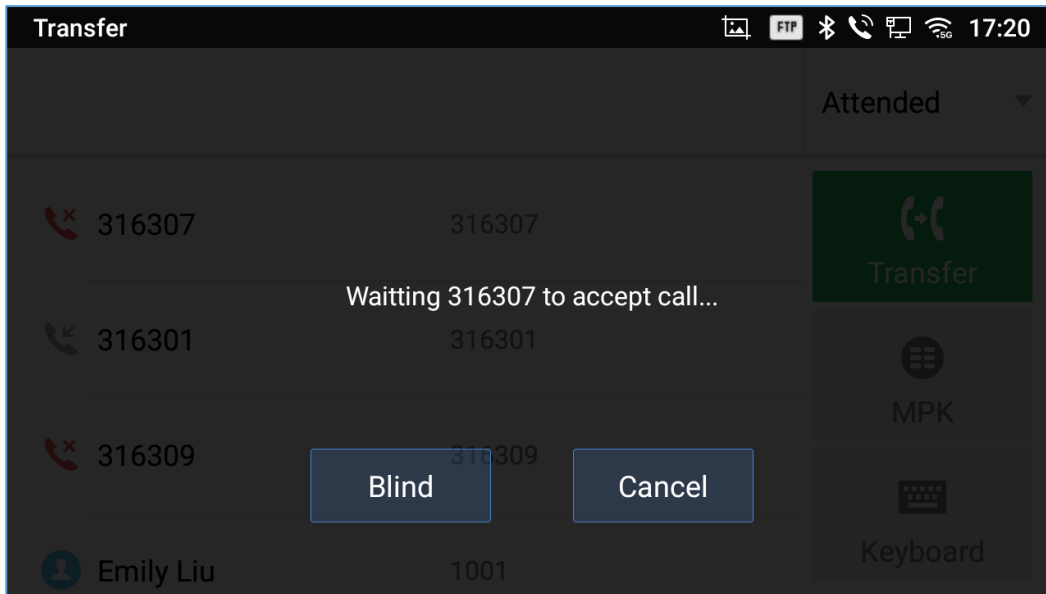

Figure 60: Attended Transfer - Transferring

5. After transfer target answers the call, the following screen will be shown up. If the user simply hangs up or taps on “End” soft key, the call will be transferred, and GXV3350 will hang up the call. If the user taps on "Split" soft key to separate the calls, the user will talk to the second established call while the first call is on hold.

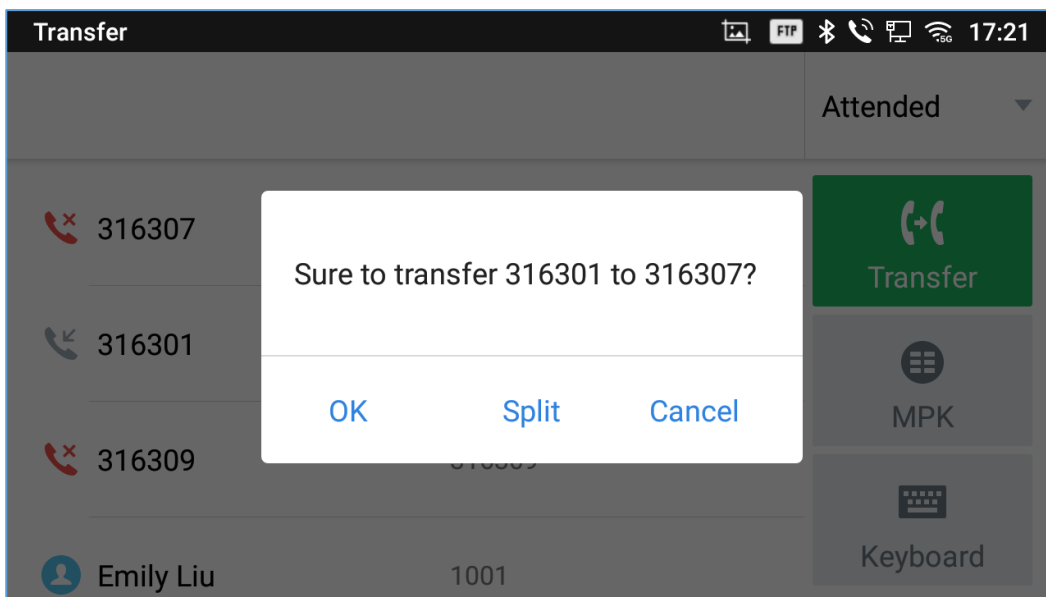



Figure 61: Attended Transfer – Split

6. Besides attended transfers above, users could also consult the third party first before transferring the call.
7. During the active call, tap More then New Call to make the second call. This will place the current call on hold.
8. The second call establishes after the call is answered.

9. During the active call, tap on "**Transfer**" button to bring up transfer screen. The other call on hold will be displayed such as  .
10. Select transfer mode as "Attended" in the transfer mode bar and tap on the call on hold such as  to transfer the call.
11. The call will be transferred, and GXV3350 will hang up the call.

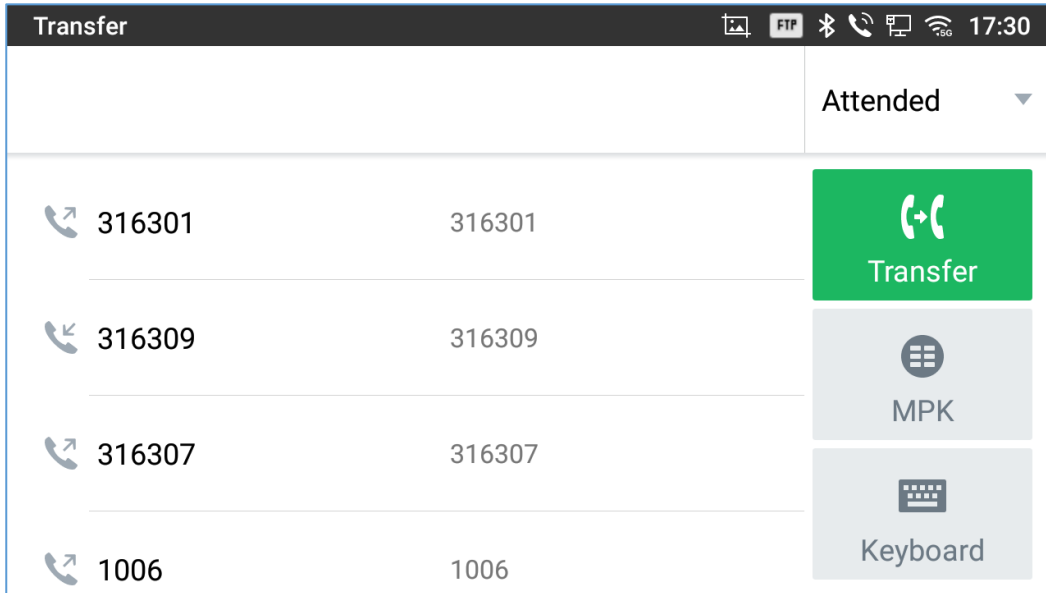

Figure 62: Attended Transfer

Transfer via MPKs

Users have the possibility to transfer calls via Transfer or non-transfer programmable keys (BLF keys)

1. During an active call, press the **Transfer** softkey then press on **MPK**

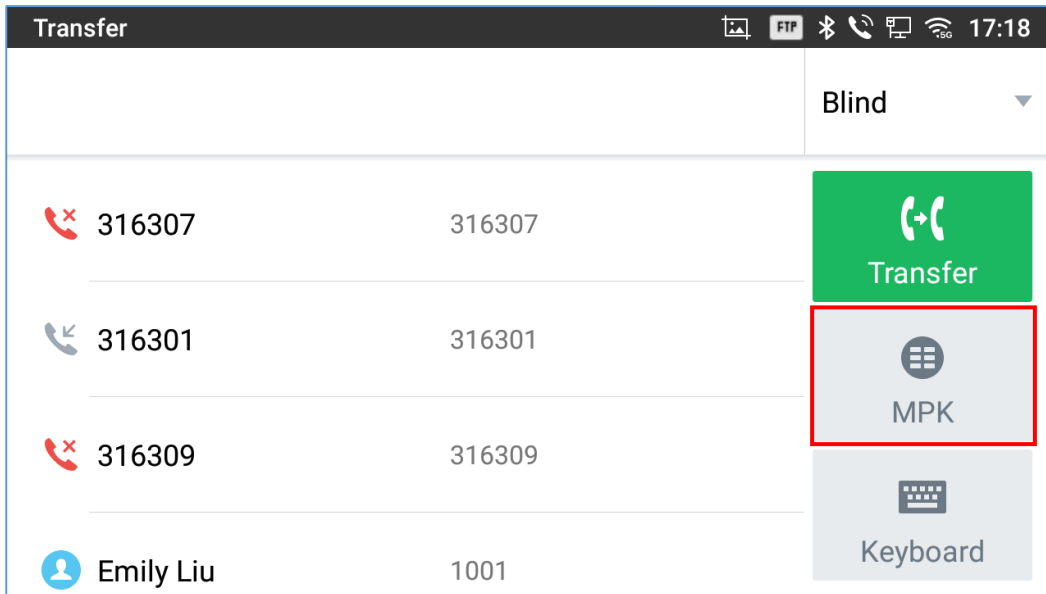

Figure 63: Transfer via MPK

2. Choose the destination to transfer calls to from the MPKs list

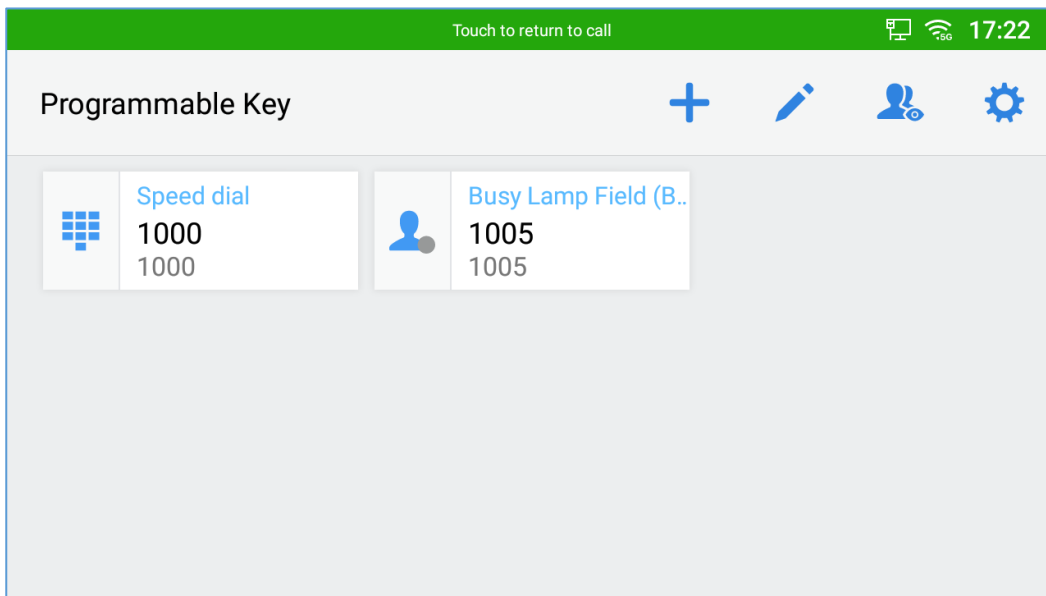



Figure 64: MPK list

Note: The transfer via programmable keys will follow the Default Transfer Mode whether it's Blind Transfer or Attended Transfer specified in WEB UI under Phone Settings -> Call Settings -> Default Transfer Mode.

 **Note:**

- To transfer calls across SIP domains, SIP service providers must support transfer across SIP domains;
 - If users would like to cancel the transfer, press  button to go back to the previous talking screen.
-

6-Way Conference

The GXV3350 supports up to 6-way Audio conferencing and 3-way HD Video conferencing.

Initiate Conference

There are three ways to initiate a conference call.

- **Initiating conference from dial screen**

1. Bring up the dial screen using one of the methods described previously **[Figure 35: GXV3350 Dial Screen]**.
2. Enter the extension number then press on it on the left panel of the screen

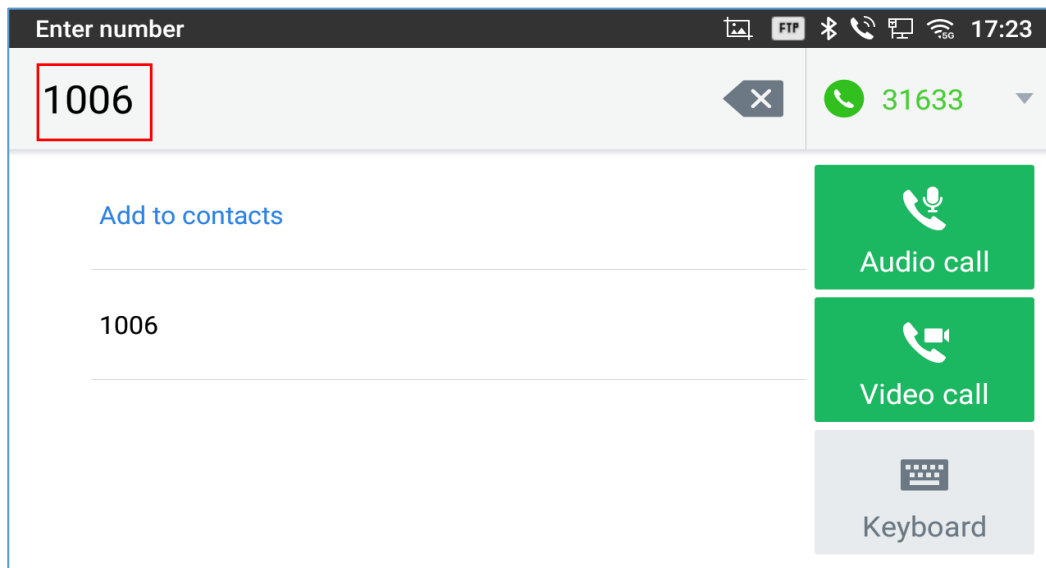

Figure 65: Add Conference Members from Dial Screen

3. The extension number will be added to dialing field and users can dial another number

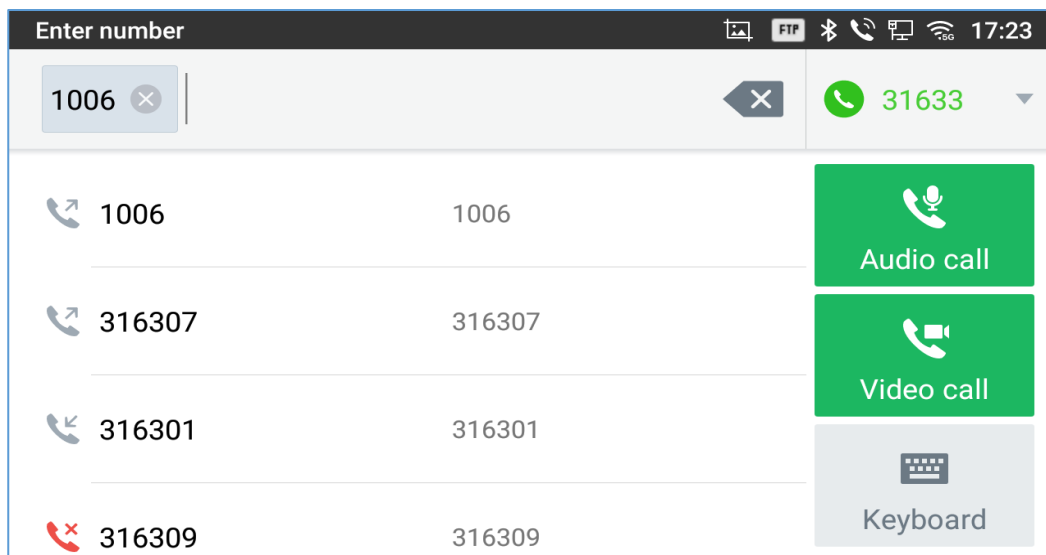



Figure 66: Add Conference Members from Dial Screen 2

4. Using the same method add the other members then press “Audio Call” for an Audio conference or “Video Call” for a video Conference

- **Initiating conference during a phone call**

1. When the phone is on call screen, tap on "**Conference**" button;
2. Enter the third-party number or choose an available number on the left menu from call history or contacts to form a conference of 3. After the call is established, the conference screen is brought up;
3. Tap on  to add another member to the conference;

- **Initiating conference directly using conference soft key**

1. On idle screen, press “**Conference**” button.
2. Tap on  to add the members of the conference.

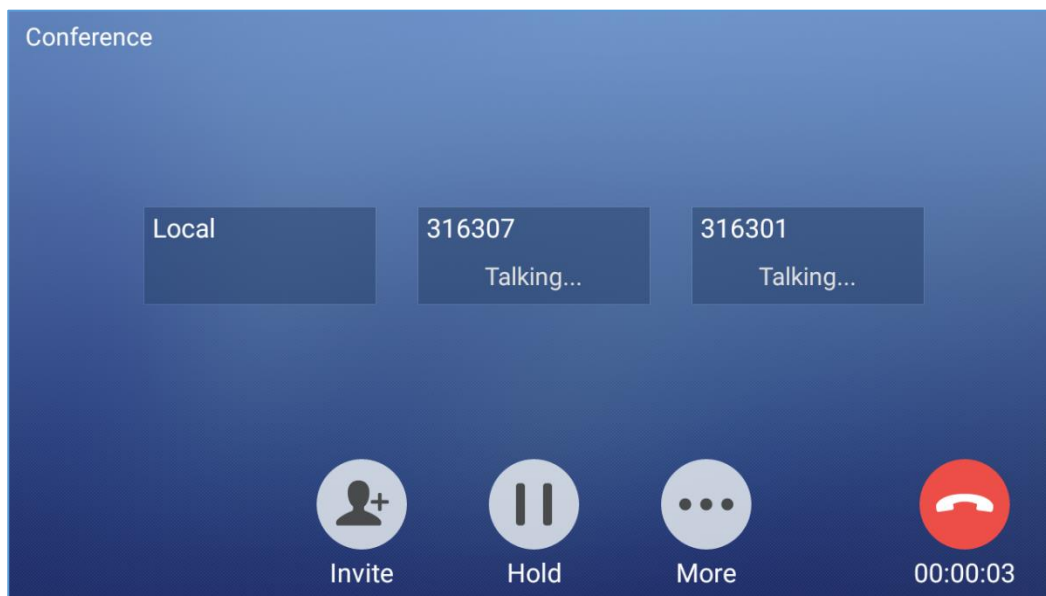



Figure 67: GXV3350 Conference Screen

Note: When users press on  to invite another member to the conference, a dial tone will be heard for the user to start dialing the number.

If there are calls on hold, they will show up when adding member to the conference. Users could then tap on the call to add it to the conference directly.

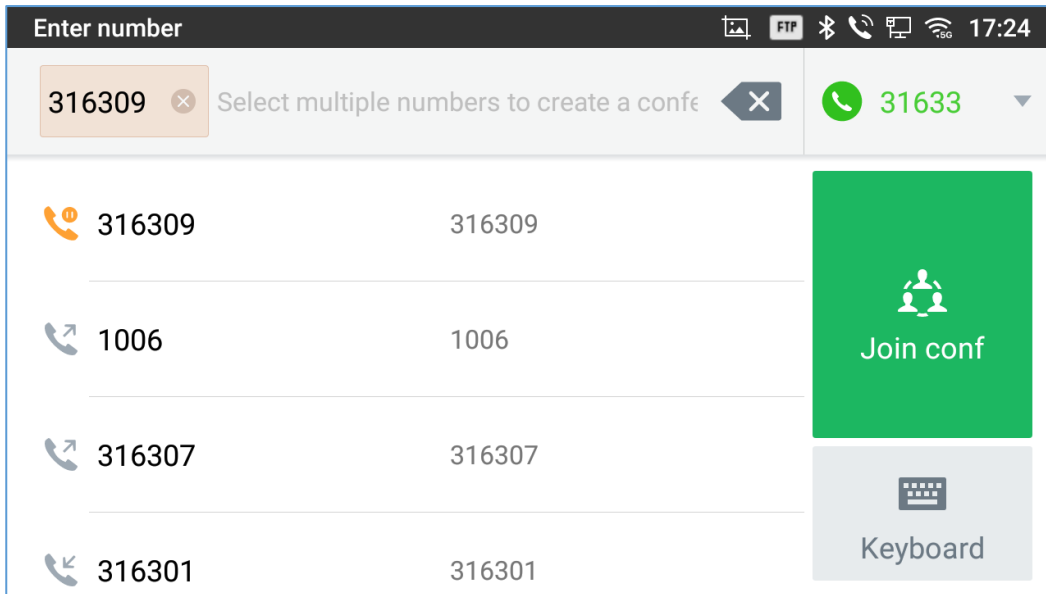

Figure 68: GXV3350 Conference - Add Existing Call to Conference

- Repeat the above steps to add more parties into the conference. The following figure shows a 3-way conference established.

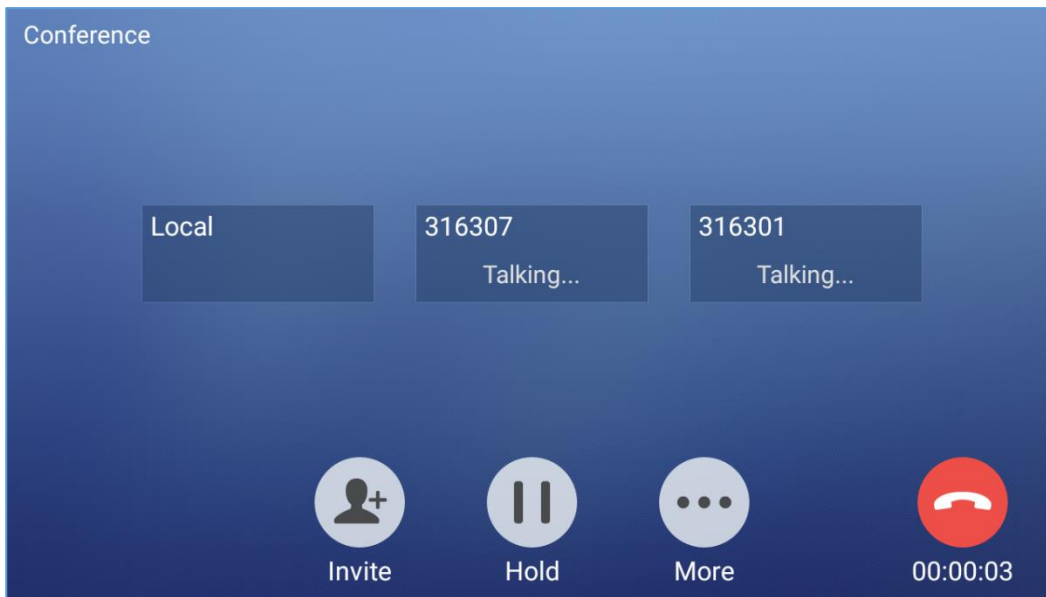

Figure 69: 3-Way Conference Call Established

Note: Every time a conference participant joins or exits the conference when using Full screen, a notification will appear in order to make the GXV3350 host aware of the participant’s actions during the conference.

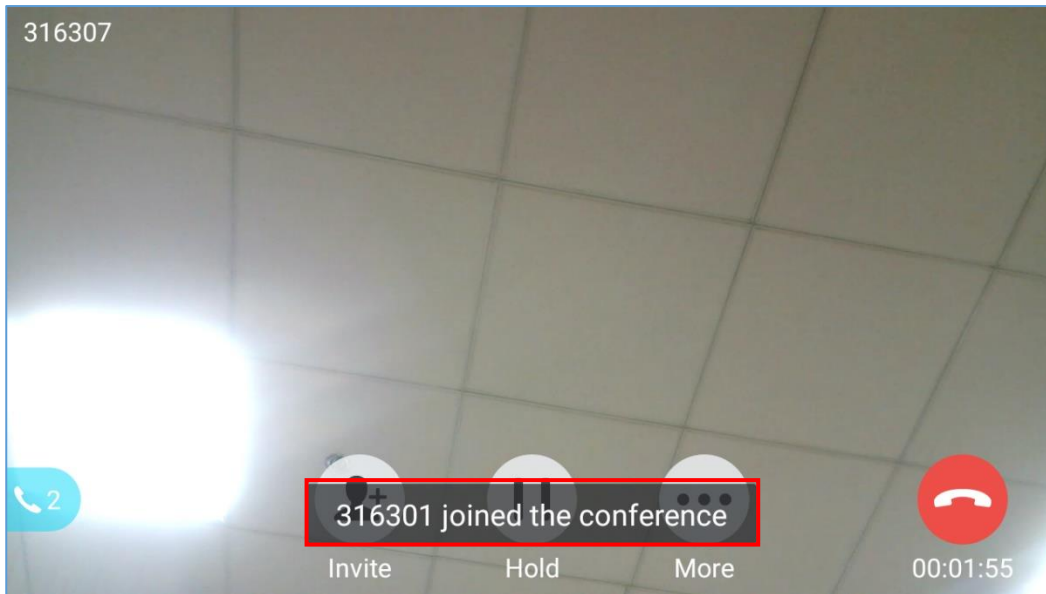

Figure 70: Notification of joining the conference

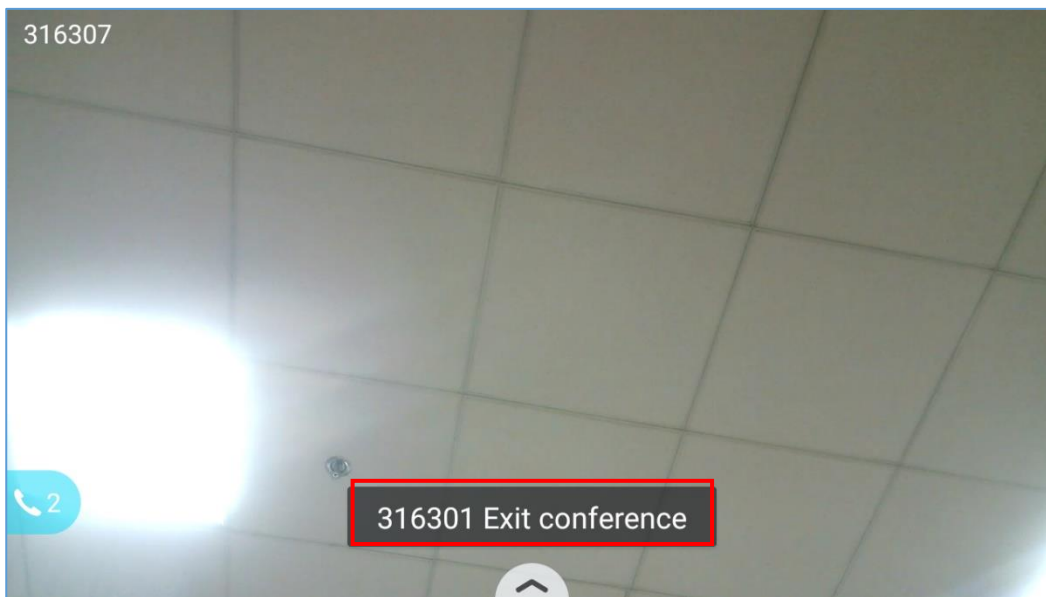



Figure 71: Notification of exiting the conference

Remove Party from Conference

To remove a party from the conference:

1. Tap on the participant icon of the user you want to remove. The below window will show up giving the possibility to Mute enable video Enlarge or hang up.
2. Tap on icon  to remove the a party from the conference.

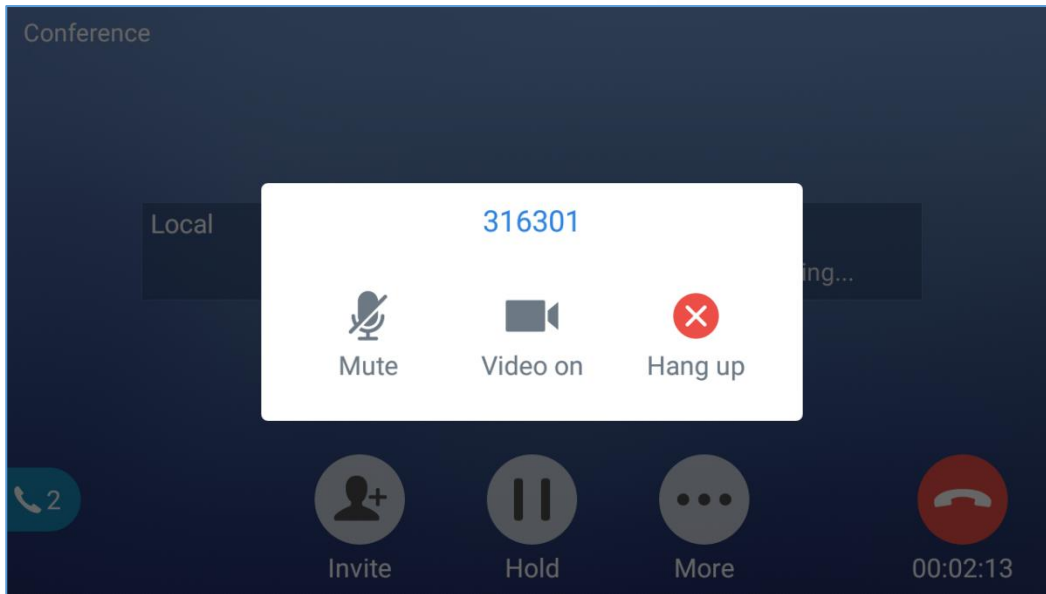



Figure 72: GXV3350 Conference - Remove Party from Conference

End Conference

To end the conference, tap on  to disconnect all the parties from the conference. GXV3350 will hang up the call. If the remote party hangs up the call itself, it will be disconnected from the conference but other parties on GXV3350 will stay in the existed conference.

Hold and Resume Conference

During the conference, users could tap on Hold to hold the conference at any time. To resume the call tap on Unhold.

Auto Conference Mode

The GXV3350 also supports "Auto Conference" which allows users to establish conference call in a quick and easy way, instead of adding the other parties one by one. To enable Auto Conference feature, go to web GUI→**Phone Settings**→**Call Settings**→**Call Features** and set "**Auto Conference**" to "Yes".

To establish call with auto conference when there are 1 or more calls on the GXV3350, simply tap on "Conf" button. All the calls on GXV3350 will be brought into the conference.

UCM Conference

Participate in UCM Conference Room

Users could dial the UCM conference room extension to join the conference. If password is required, enter the password to join the conference as a normal user, or enter the admin password to join the conference as administrator.



Figure 73: Join UCM Conference Room

CCM (Conference Call Menu)

During a UCM conference, Administrators can tap on the UCM conf menu 

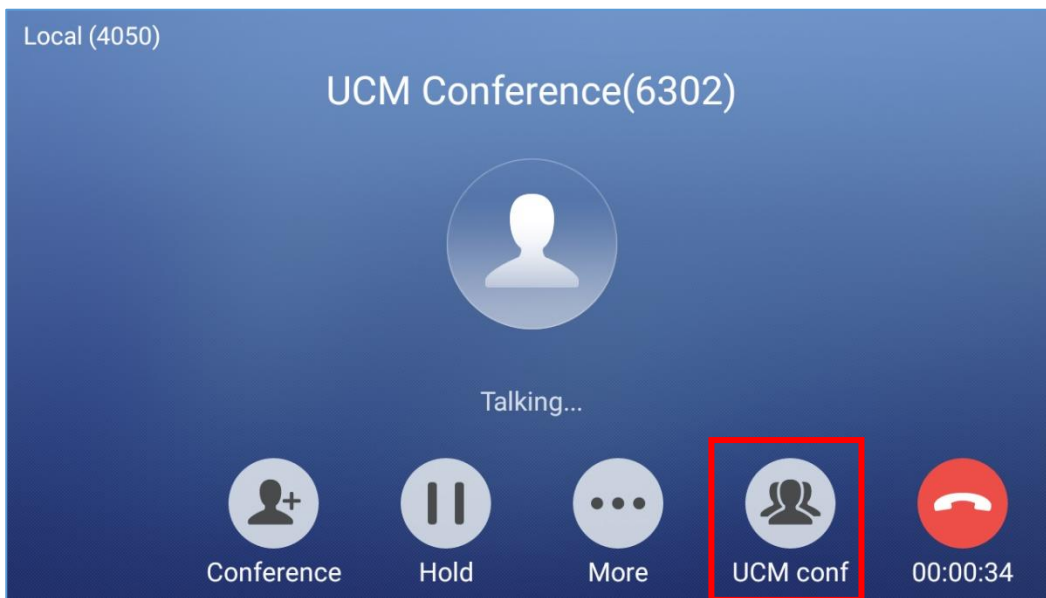

Figure 74: UCM conference Menu

Administrators could view/invite members, bridge conference, remove bridge, mute, unmute and lock the conference

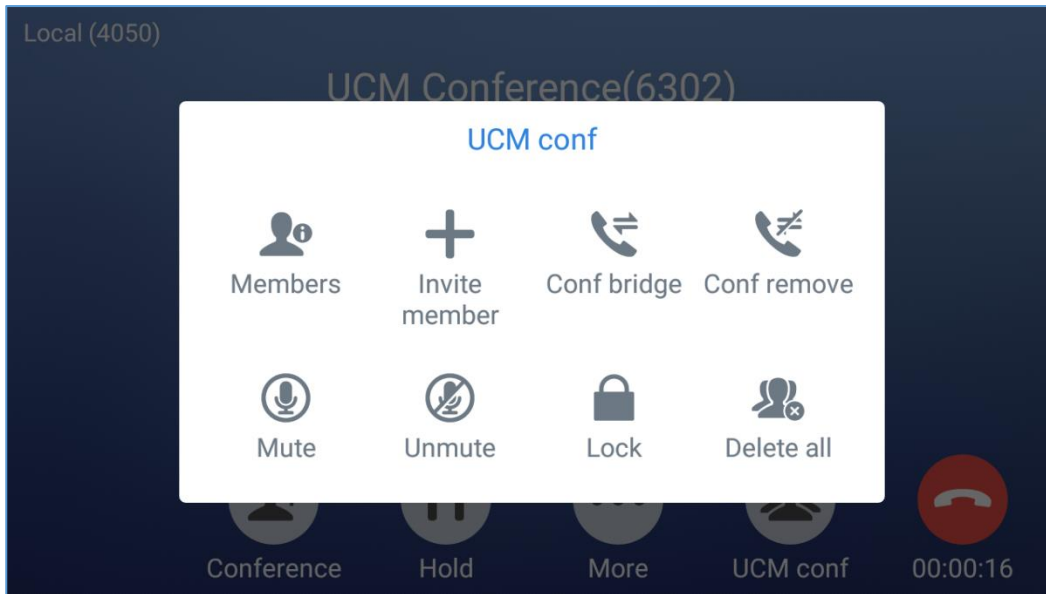



Figure 75: Conference Menu Options

Conference Call Operations

- Click on  to list all the users currently in the conference

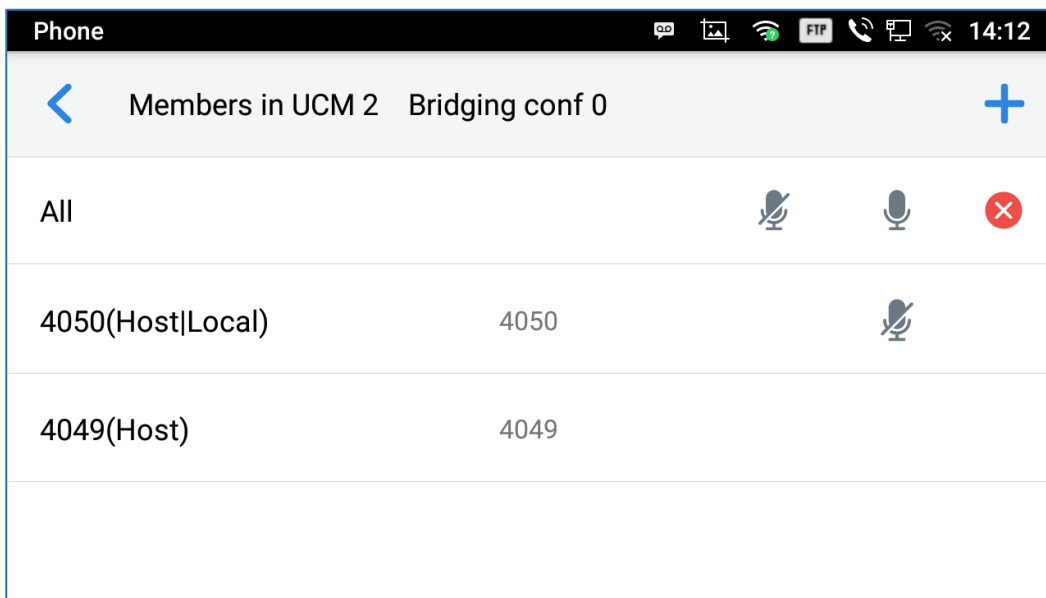



Figure 76: Conference's members list

- Click on  to invite other users into the conference room.

Users can send invitations to others to participate in the conference by pressing on the Invite option and then enter the member number an invitation will be sent to that number to join the conference room.

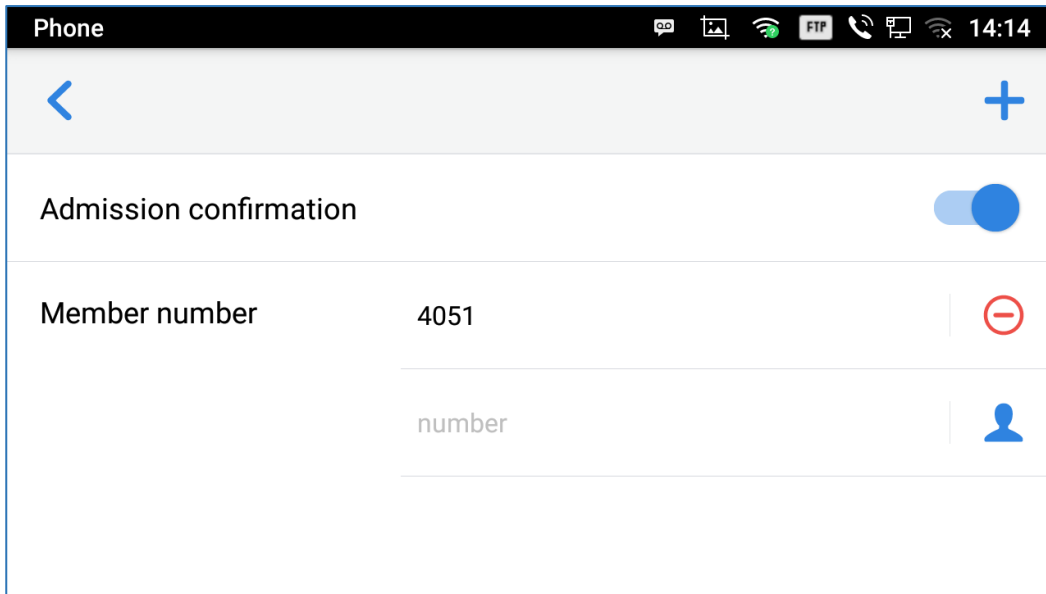



Figure 77: Invite a member

- Click on  to bridge another conference, Enter the conference number and password and Bridge request will be sent.

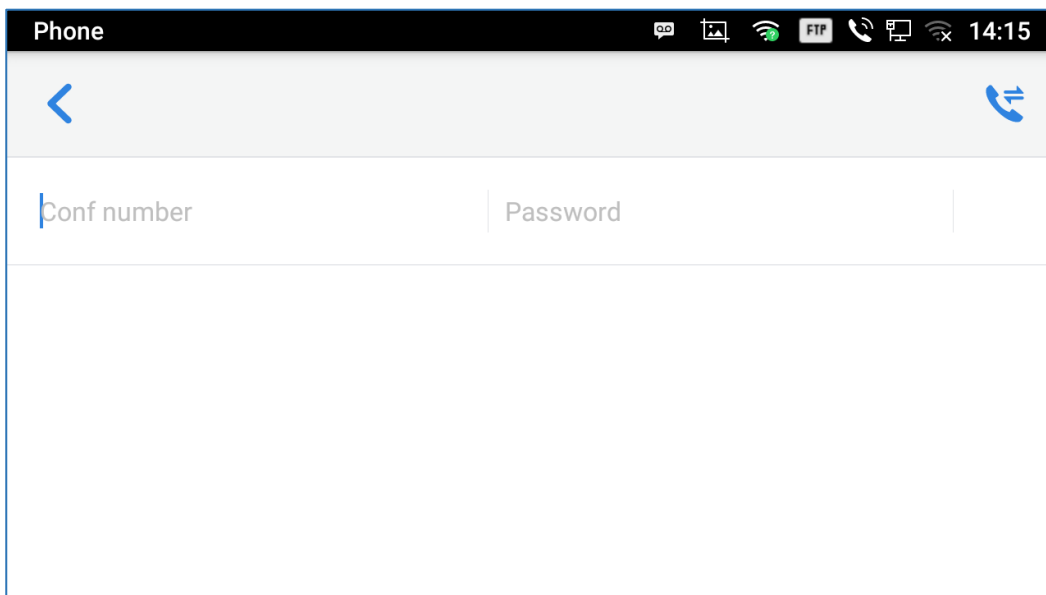







Figure 78: Conference Bridge

- Click on  to remove Conf Bridging.
- Click on  to Mute conference.
- Click on  to Unmute.
- Click on  to lock this conference room so that other users cannot join it anymore.

- Click on  to remove all members who are not the hosts.

CEI (Conference Event Indicator)

If CEI is enabled, Events like members joining/Leaving the conference, Invitation sent, Mute/Unmute ... will be displayed in the call screen as the examples shown below:



Figure 79: Mute all members

Missed Call

When there is a missed call, the LCD will show missed call dialog on the idle screen.

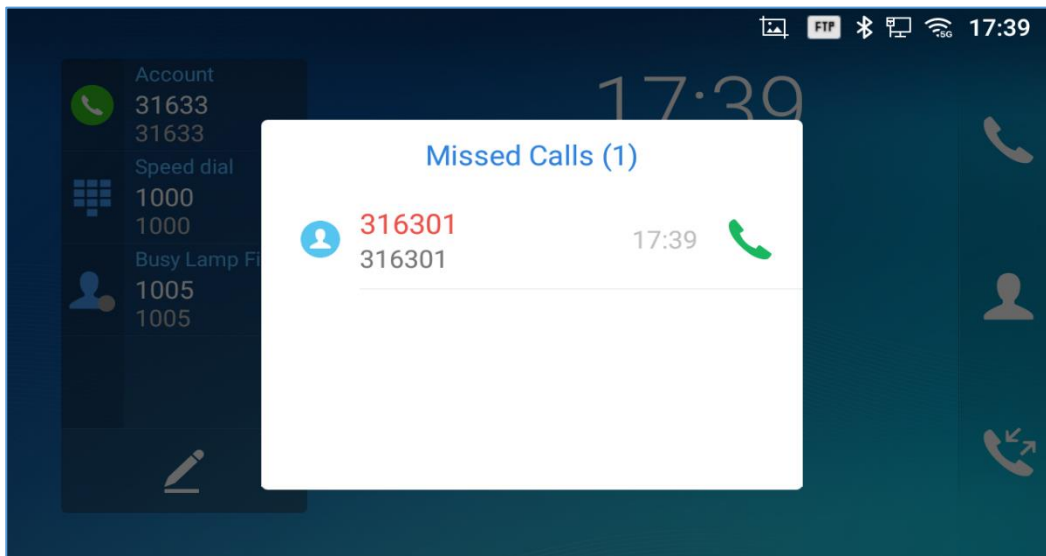





Figure 80: Missed Call Screen

Users can tap on the missed call entry to access the missed call log. To close the missed call screen and return to the idle screen, tap on the screen except the dialog.

DND (Do Not Disturb)

When DND is on, the incoming calls to the GXV3350 will be blocked for all registered accounts with a reminder ring produced. To turn on/off DND:

1. Touch and drag the status bar down on the GXV3350 idle screen.
2. Tap on the DND icon  to turn it on. The status bar shows icon  indicating DND is on.
3. Tap on the DND icon  to turn it off.

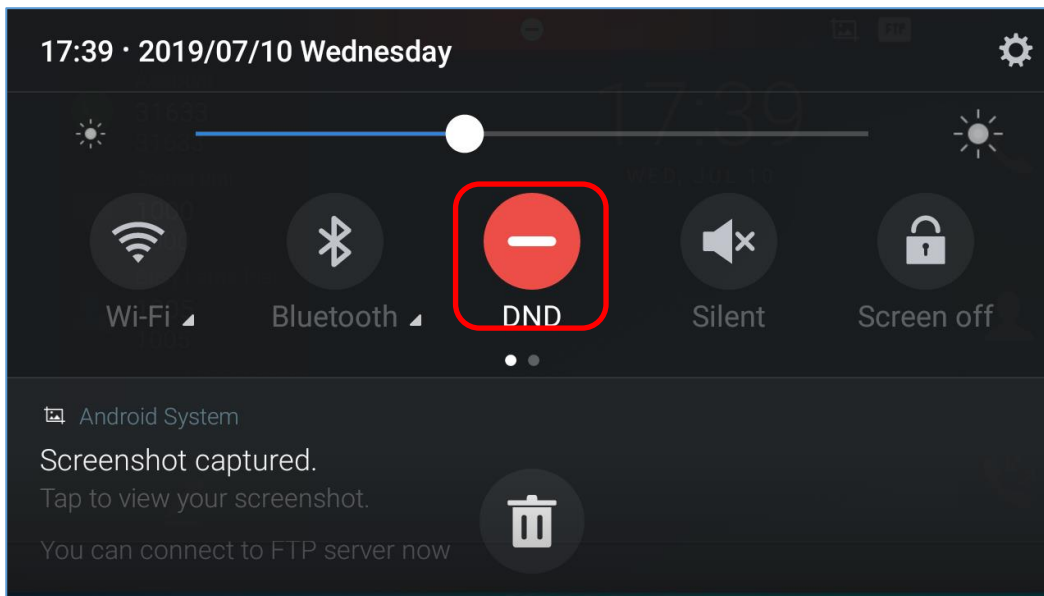



Figure 81: Enable/Disable DND

Note:

- When the phone is in an active call, turning on/off DND won't affect the current active call. It will take effect starting from the next incoming call.
- When DND is on, all the incoming call logs will be saved in Missed.

Voicemail/Message Waiting Indication

When there is a new voicemail, the Message Waiting Indication (MWI) LED icon will blink in red on the upper right corner of the GXV3350 and  will show up in the status bar.

To retrieve the voicemail:

1. Tap on the Message icon  from the applications section to bring up voicemail screen. All the registered accounts and the number of voicemails are displayed there.
2. Tap on the account to dial into the voicemail box. Then follow the Interactive Voice Response (IVR) for the message retrieval process.

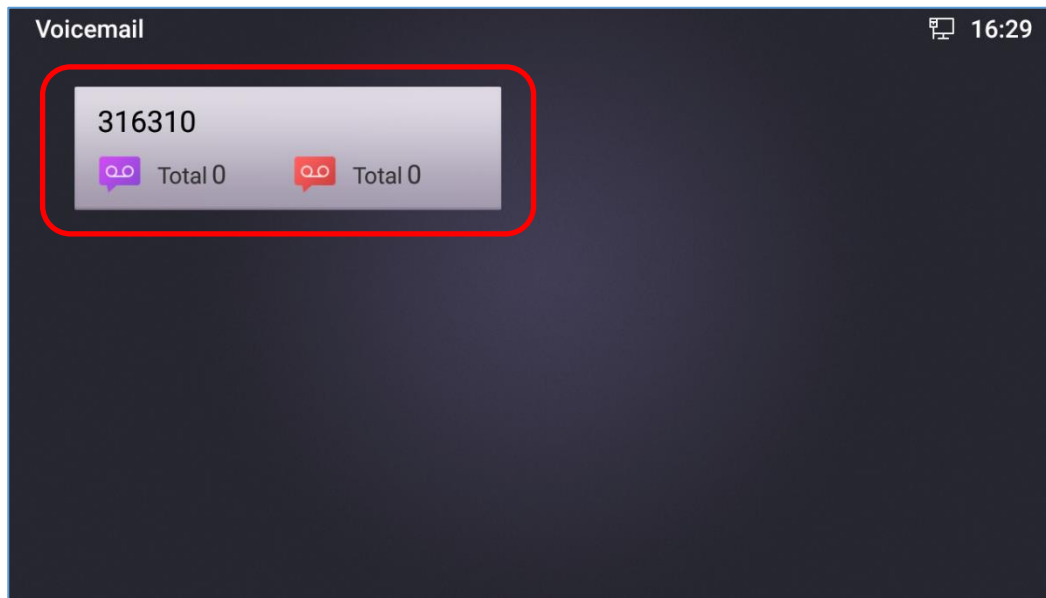

Figure 82: Retrieve Voicemail

For each account, the Voicemail User ID can be set up under web GUI→**Account X**→**General Settings**: "Voicemail Access Number". This is the number that will be dialed out to access voicemail message when tapping on the account in Voice Mail screen.

Call Forward

Call forward feature can be set up from GXV3350 LCD or Web GUI.

- **From LCD**

Go to onscreen Menu→**Settings**→**Features**→Call Forward. Select account name and tap on **Call Forwarding** to activate the feature. Then the list of options will be available. Select the option Call Forward Mode to configure the call forward type (Unconditional, Time Based, Others) and then enter necessary number in the fields.

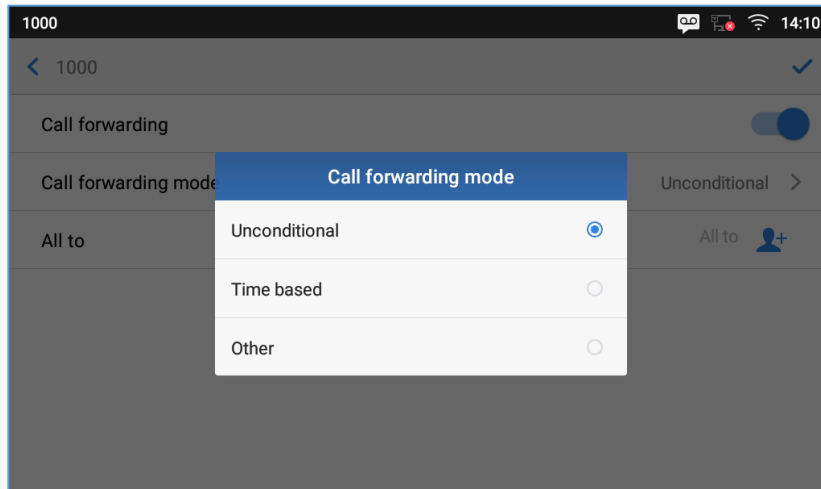

Figure 83: Unconditional Call Forward

- **From Web GUI**

Log in GXV3350 web GUI and go to **Account page**→**Call Settings**. By default, Call Forward feature is set to "None". The Call Forward feature options are:

- **Unconditional Forward:** All the incoming calls will be forwarded to the number set up in "All To" field.

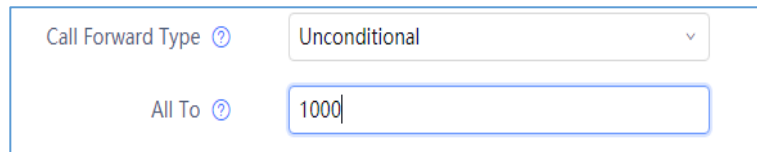

Figure 84: Call Forward – Unconditional

- **Time Based Forward:** All the incoming calls will be forwarded to the number as schedule in the time period. During the setup time, the call will be forwarded to the number in "In Time Forward To:" field. Other period the call will be forwarded to the number in "Out Time Forward To:" field.

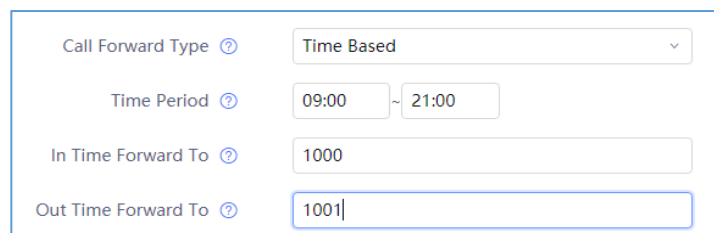

Figure 85: Call Forward - Time Based

- **Call Forward on Busy / Call Forward No Answer / Call Forward on DND:** The incoming call will be forwarded when the GXV3350 is busy or no answer after certain interval "Delayed Call Forward Wait Time (s)", or if the phone is on DND mode then the call will be forwarded to the configured destination number.

Call Forward Type ?	<input type="text" value="Others"/>
Enable Busy Forward ?	<input type="checkbox"/>
Busy To ?	<input type="text"/>
Enable No Answer Forward ?	<input type="checkbox"/>
No Answer To ?	<input type="text"/>
No Answer Timeout (s) ?	<input type="text" value="20"/>
Enable DND Forward ?	<input type="checkbox"/>
DND To ?	<input type="text"/>

Figure 86: Call Forward - Busy/No Answer/DND

Call Features

The GXV3350 supports traditional and advanced telephony features including caller ID, caller ID with caller Name, call waiting, call forward etc. Before using the following feature codes, please make sure "Enable Call Features" option is set to "Yes" under web GUI → **Account** page → **Call Settings**.

Table 10: GXV3350 Feature Code

*01	<p>Use Preferred Codec (per call)</p> <ul style="list-style-type: none"> • Dial *01 followed by the preferred codec code and the phone number. • The phone will try to use this codec during the call. • Codec code: PCMU: 7110 PCMA: 7111 G726-32: 72632 G722: 722 iLBC: 7201 <p>For example, if the user would like to use PCMA as the preferred codec to call phone number 334455, enter *017111334455.</p>
------------	---

*02	<p>Force Codec (per call)</p> <ul style="list-style-type: none"> • Dial *02 followed by the preferred codec code and the phone number. • The phone will be forced to use this codec during the call. • Codec code: PCMU: 7110 PCMA: 7111 G726-32: 72632 G722: 722 iLBC: 7201 <p>For example, if the user would like to use PCMA to call phone number 334455, enter *027111334455.</p>
*30	<p>Block Caller ID (for all subsequent calls)</p> <ul style="list-style-type: none"> • Dial *30.
*31	<p>Send Caller ID (for all subsequent calls)</p> <ul style="list-style-type: none"> • Dial *31.
*50	<p>Disable Call Waiting</p> <ul style="list-style-type: none"> • Dial *50.
*51	<p>Enable Call Waiting</p> <ul style="list-style-type: none"> • Dial *51.
*67	<p>Block Caller ID (per call)</p> <ul style="list-style-type: none"> • Dial *67 followed by the phone number.
*82	<p>Send Caller ID (per call)</p> <ul style="list-style-type: none"> • Dial *82 followed by the phone number.
*70	<p>Disable Call Waiting (per Call)</p> <ul style="list-style-type: none"> • Dial *70 followed by the phone number.
*71	<p>Enable Call Waiting (per Call)</p> <ul style="list-style-type: none"> • Dial *71 followed by the phone number.
*72	<p>Unconditional Call Forward. To set up unconditional call forward:</p> <ul style="list-style-type: none"> • Dial *72 followed by the phone number to forward the call.
*73	<p>Cancel Unconditional Call Forward. To cancel the unconditional call forward:</p> <ul style="list-style-type: none"> • Dial *73.
*74	<p>Paging Call</p> <ul style="list-style-type: none"> • Dial *74 followed by the phone number to send the paging call.



*83	Force Audio Calling (per call) <ul style="list-style-type: none">• Dial *83 followed by the phone number to send the audio call.
*84	Force Video Calling (per call) <ul style="list-style-type: none">• Dial *84 followed by the phone number to send the video call.
*90	Busy Call Forward. To set up busy call forward: <ul style="list-style-type: none">• Dial *90 followed by the phone number to forward the call.
*91	Cancel Busy Call Forward. To cancel the busy call forward: <ul style="list-style-type: none">• Dial *91.
*92	Delayed Call Forward. To set up delayed call forward: <ul style="list-style-type: none">• Dial *92 followed by the number to forward the call. The default timeout before the call is forwarded is 20 seconds.
*93	Cancel Delayed Call Forward. To cancel the delayed call forward: <ul style="list-style-type: none">• Dial *93.

CONTACTS

The GXV3350 supports local, LDAP Contacts.

To access GXV3350 contacts, on the phone's idle screen, tap on icon  on the right panel. The following figure shows Contacts on the GXV3350.

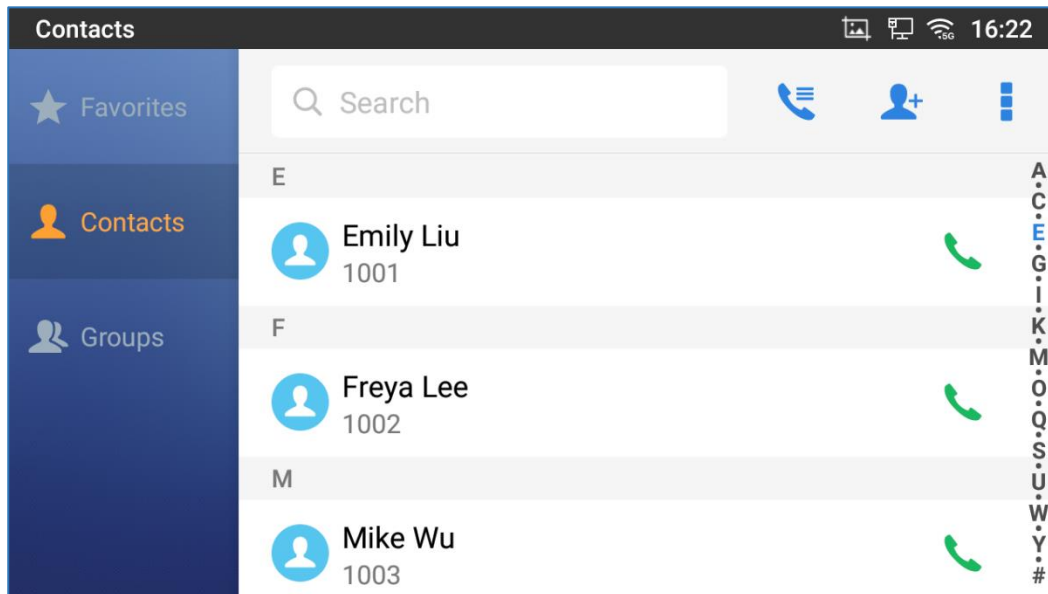



Figure 87: GXV3350 Contacts

Local Contacts

The local contacts can save up to 1000 entries. Users can manage contacts by adding, deleting and modifying single contacts, downloading contacts from HTTP/TFTP server, importing contacts from external storage and exporting contacts to external storage.

Note: A reminder prompt is shown on the GXV3350 LCD screen when adding a number of contacts more than the allowed one (when importing contacts for instance).

Add Single Contacts

1. On the Local Contacts menu Tap on  to bring up "Create Contact" dialog to manually add a new contact. See

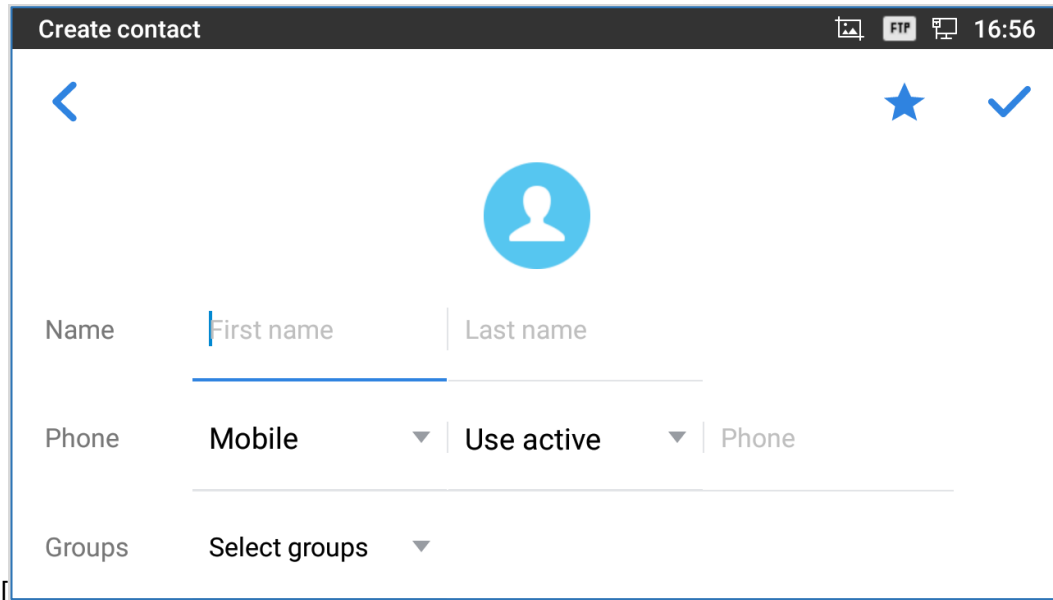

2. **Figure 88: GXV3350 Contacts - Add** New Contact].

3. Type First name, Last name, Phone number and other information for the new contacts. Please make sure the account number field is selected so the GXV3350 will use this account to dial out the new contact. The account number field is located on the left of the "Phone" field as highlighted below.

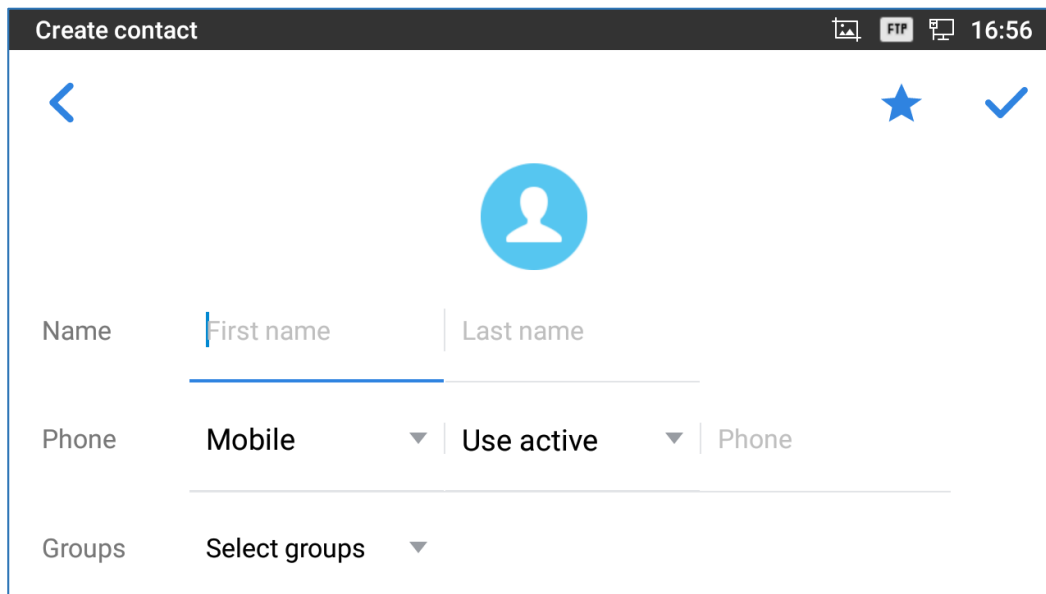

Figure 88: GXV3350 Contacts - Add New Contact

Note: When typing a number using dial pad, “Add to contacts” button will appear as displayed on following picture, to add a new entry to your contacts list if the input number does not match any entry in your contacts.

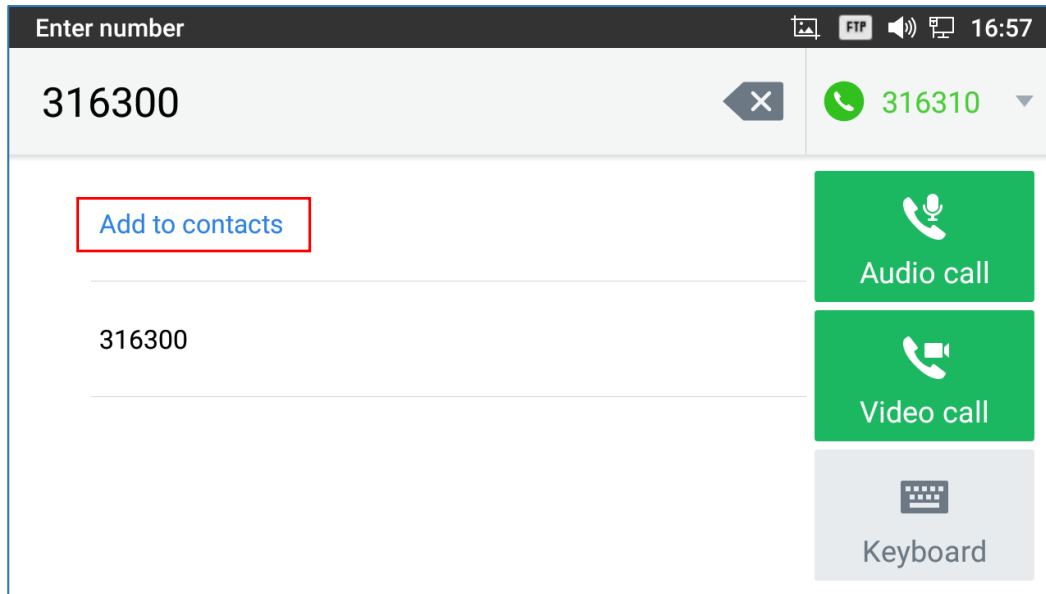



Figure 89: Add to Contacts from Dial Pad

Import/Export Contacts

If the users have the GXV3350 phonebook file saved in local storage or external storage device that has been plugged into the GXV3350, the phonebook file can be directly imported to the Contacts. There are two different formats supported for the phonebook file: "vcard", and "xml". Users could manually create contacts first and export the phonebook file in vcard or xml format to take a look on the phonebook file.

To Import Contacts:

1. Open Contacts.
2. Tap on More  on the upper right corner of the Contacts screen.
3. Select "Import contacts" to bring up the dialog below.
4. Fill in the import options and scroll down to the bottom of the screen.
5. Tap on "Select file" to import phonebook file from the directory in internal or external storage device.

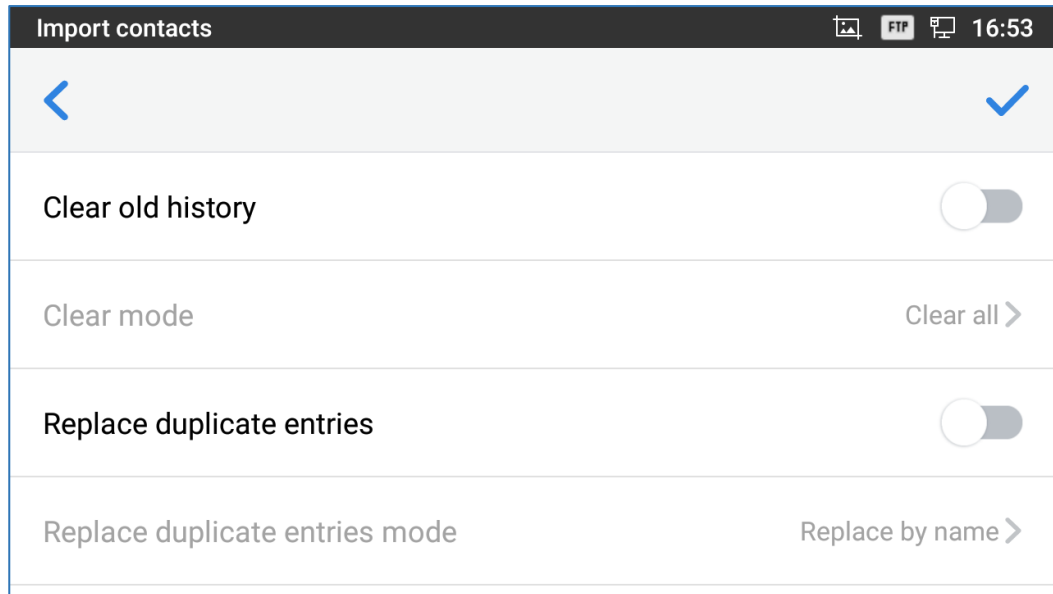



Figure 90: GXV3350 Contacts - Import Contacts

To Export Contacts:

1. Open Contacts.
2. Tap on More  on the upper right corner of the Contacts screen.
3. Select "Export Contacts " to bring up dialog below.
4. Select the file encoding and file type for the exported phonebook file. By default, the GXV3350 is using "UTF-8" as the encoding method.
5. Tap on "Choose Directory" and select the directory where the phonebook file will be exported to.

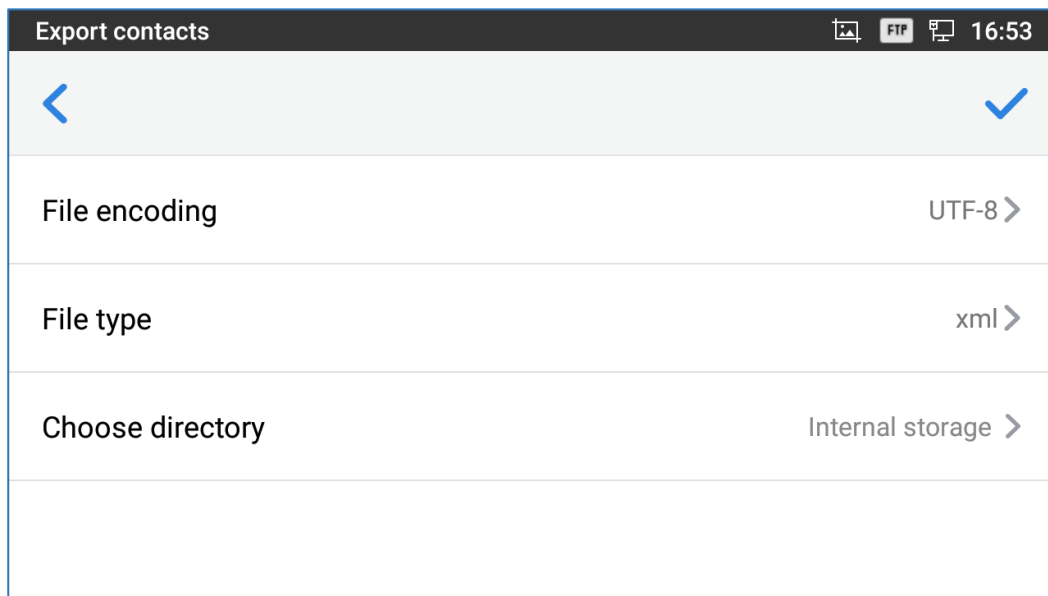



Figure 91: GXV3350 Contacts - Export Contacts

Download Contacts

The GXV3350 supports downloading XML phonebook from a remote HTTP/TFTP/HTTPS server to local Contacts. When downloading the phonebook, the GXV3350 sends request to the HTTP/TFTP/HTTPS server looking for file **phonebook.xml**. For more details about GXV3350 phonebook, please refer to the following link:

http://www.grandstream.com/sites/default/files/Resources/gxv3275_xml_phonebook_guide_1.pdf

To download phonebook:

1. Make sure the GXV3350 can connect to the HTTP/TFTP/HTTPS server and the phonebook.xml file in correct format is downloadable from the HTTP/TFTP/HTTPS server.
2. Open Contacts.
3. Tap on More  on the upper right corner of the Contacts screen.
4. Select "Download Contacts" to bring up the dialog below.
5. Fill in the necessary options and then tap on  in the upper right corner of the screen. The GXV3350 will send out request to the configured HTTP/TFTP/HTTPS server.

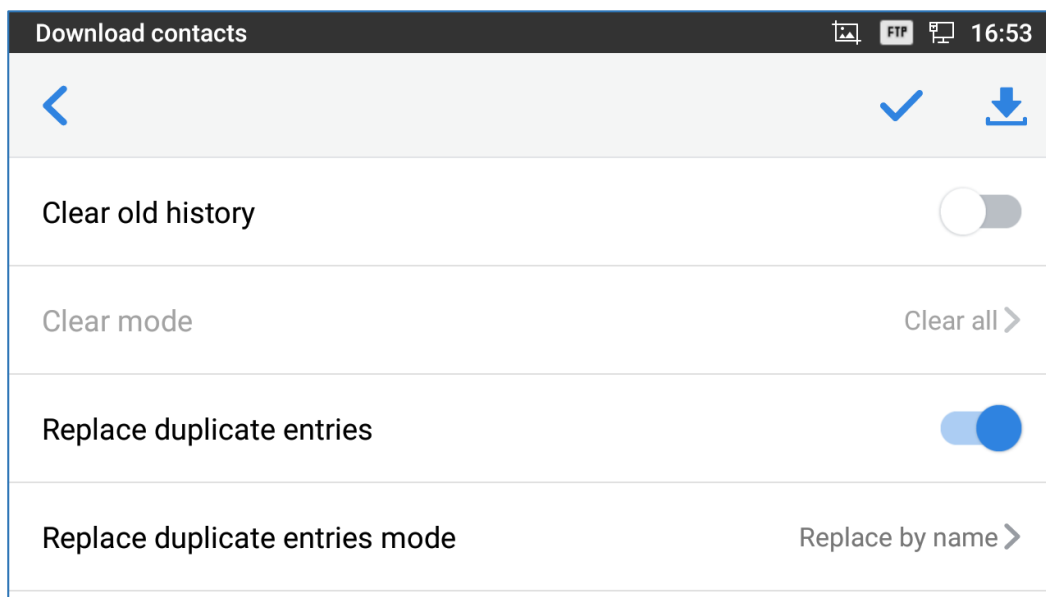



Figure 92: GXV3350 Contacts - Download Contacts

Search Contacts

1. Open Contacts.
2. Tap on the search field .



3. Enter a contact's name or a number to search. The search result will be automatically updated and displayed when entering the key words.

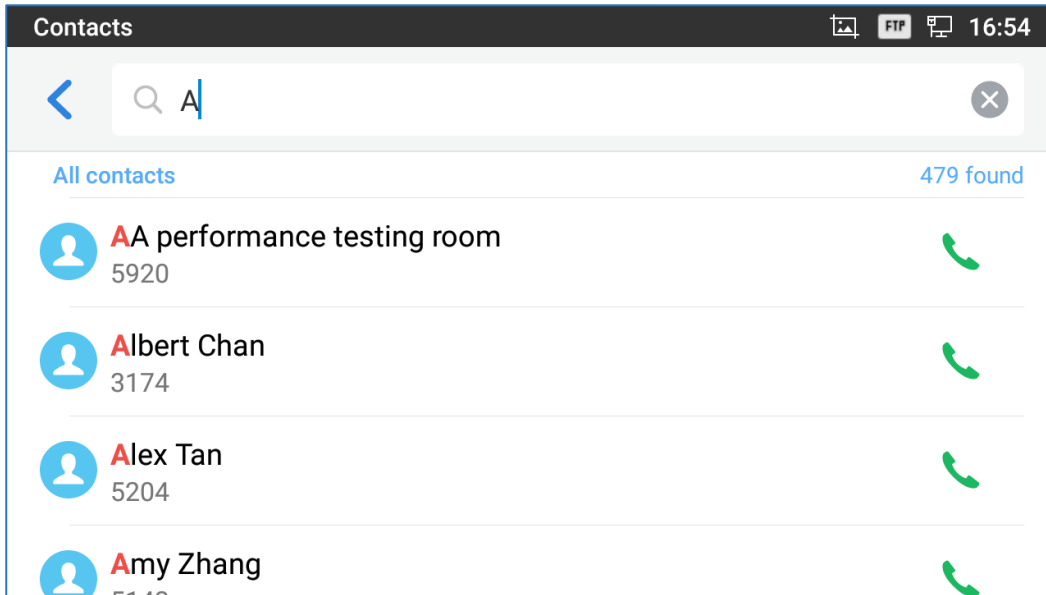



Figure 93: GXV3350 Contacts - Search Contacts

Use Contacts

Once the contacts are added, users could navigate in the contacts list  to make a call and manage the contacts furthermore.

Make a Call to Contacts

Scroll up/down to find the contact in the list and tap on  to call this contact.

Select Contacts

1. Scroll up/down to find the contact in the list.
2. Touch and press on the contact for about 2 seconds to show more options such as Delete contact, add to blacklist etc.
3. To select a batch of contacts at the same time, press More  on the upper right corner of the contacts screen and select Batch operation, Tap on the checkbox for the contacts to be selected.

 indicates the contact is selected.

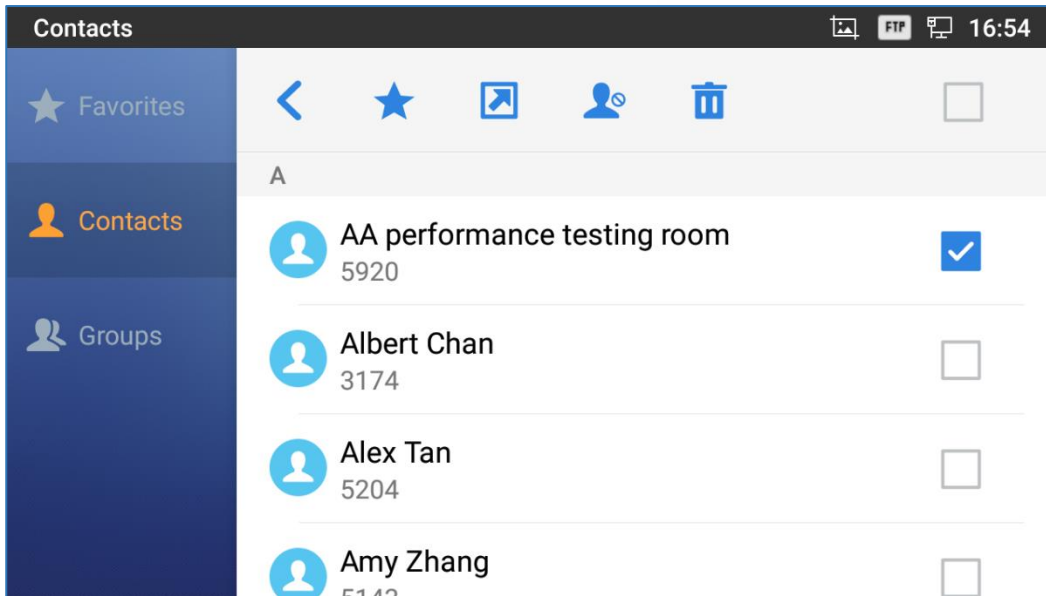





Figure 94: GXV3350 Contacts - Select Contacts

Add Contacts to Favorites

1. Select the contact/contacts to be added as described in [**Select Contacts**].
2. Then tap on  to add the contacts selected to Favorites

There are two other methods to add contacts to favorites.

- Directly pressing on the contact and tap on  to add the contact to favorite.
- Tapping on “Favorites” on the Contacts screen to navigate to favorites category and tap on  to select the contacts to be added to favorites then tap on .

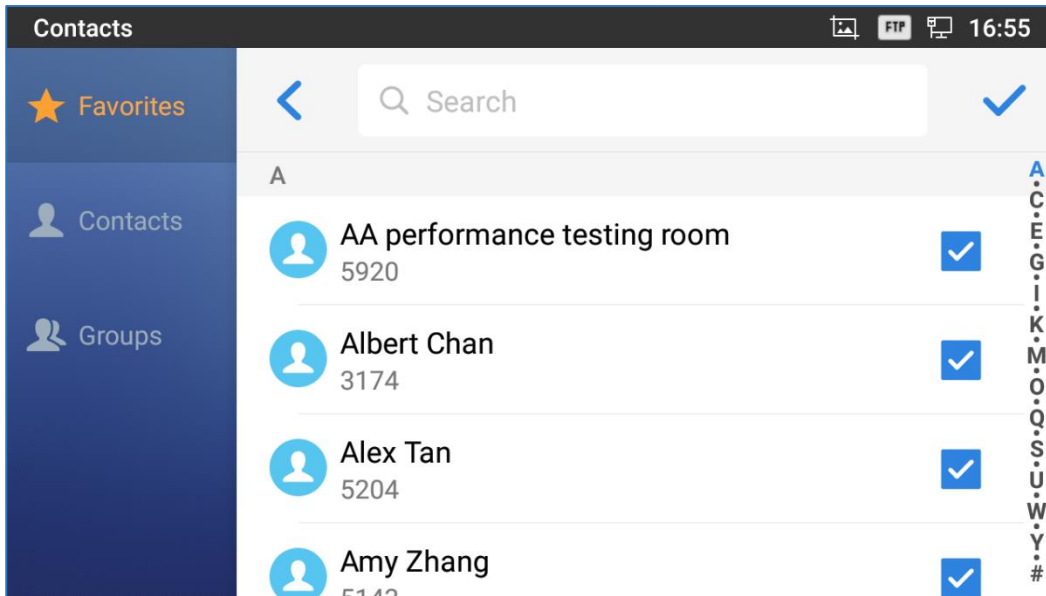



Figure 95: Add Contacts to Favorites

Edit Contacts

1. Tap on a contact from the contacts list
2. Tap on  to edit the contact.

Send Contacts to Desktop Shortcut

1. Long press on the contact
2. Tap on Send to Desktop from the menu.

Share Contacts via Bluetooth

Users can share a single contact or a batch of contacts. Refer to the following steps to do so:

- **Sharing a single contact:**

1. Long press on the contact
2. Select "Send" from the menu then choose the Bluetooth device that you want to share the contact with.

- **Sharing a batch of contacts:**

1. Select the contacts as described in [**Select Contacts**].
2. Press on  to share the selected contacts via Bluetooth

Add Contacts to Blacklist

Users can add a single contact or a batch of contacts to the black list. Refer to the following steps to do so:



- **Add a single contact to black list:**

1. Long press on the contact
2. Select "Add to Blacklist" from the menu.

- **Add a batch of contacts to black list:**

1. Select contacts as described in [**Select Contacts**].
2. Press on  to add the selected contacts to the blacklist

Add Group

Open Contacts and tap on  to access "Group". To add a new group, tap on  and name the new group.

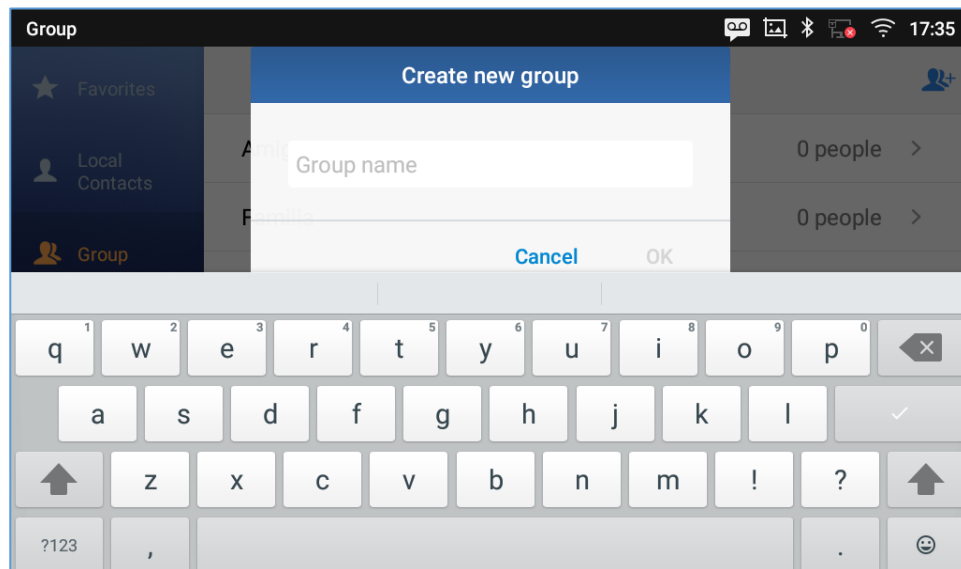



Figure 96: GXV3350 Contacts - Add New Group

Add contacts to Group

To add contacts to a group, tap on the group then tap on , check the contacts to be added to the group and press .

Note:

- Users could also select a group for the contact when adding or editing the contact.
- Ringtone can be assigned in group as well as single contact. If the group has ringtone set to "Custom Ringtone", this ring tone has the highest priority when there is an incoming call to the contact.

Contacts Storage Status

The GXV3350 default maximum contacts storage is up to 1000. To check contact storage status, tap on More on the upper right corner of the contacts screen to bring up contacts options, scroll down and select "Storage Status".

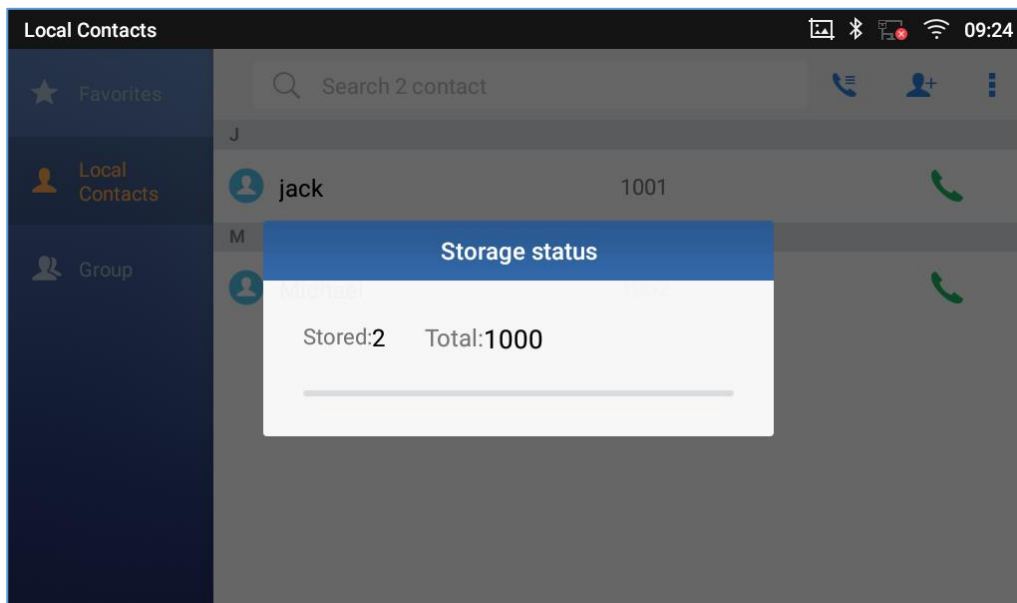

Figure 97: GXV3350 Contacts - Storage Status

Note:

Users could increase the number of maximum contacts storage to more than 1000 contacts on GXV3350. Users may access the phone through SSH and change the P value P1688 to another number (≤ 10000) to increase the default contacts storage. In this case, if users increase this default P value, the phone resource will be cost, and the phone performance will be slower.

PROGRAMMABLE KEYS

Programmable Keys Application

GXV3350 supports programmable keys without extension board (GBX20). Users can configure the programmable keys from Programmable Key application.

To configure programmable keys via Programmable Key application on GXV3350:

1. Open Programmable Key application. Tap **+** on the upper right of the app and then start adding programmable keys.
2. Select desired mode from Key mode dropdown list (Speed dial, BLF, Call Transfer, Intercom, Speed dial via active account, Dial DTMF, Call park, Multicast paging, Dial prefix and Speed conference)

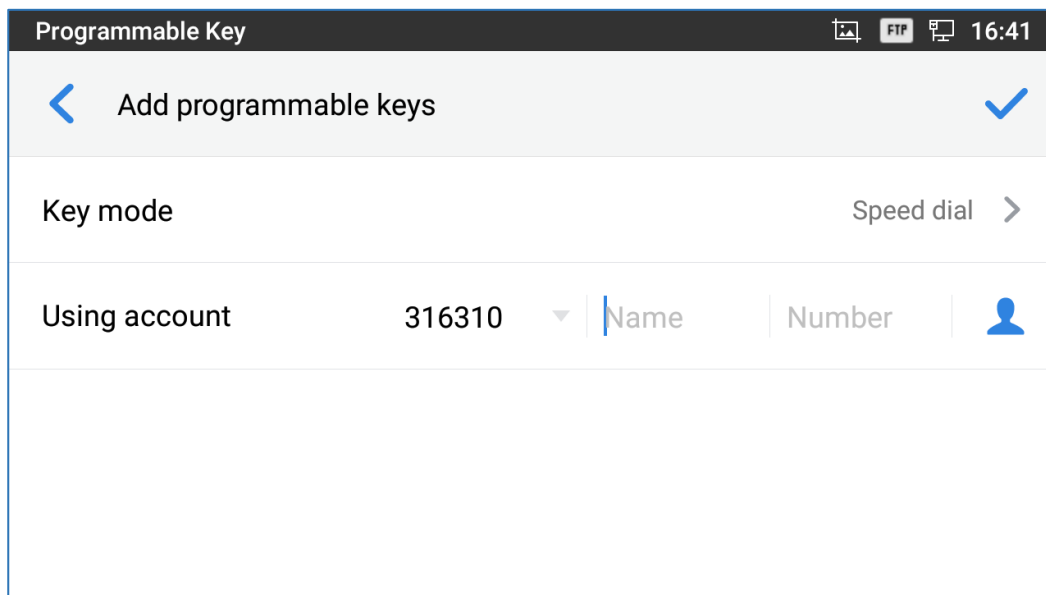

Figure 98: GXV3350 Programmable Key APP – Add Number

3. For number list, user could manually enter it or select number from Contacts to add it.

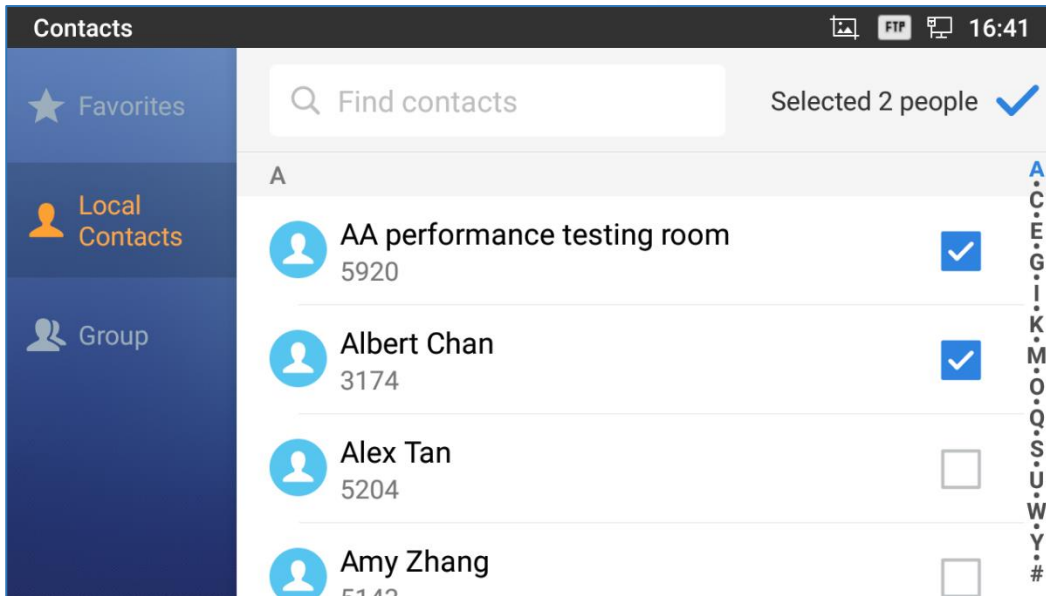

Figure 99: GXV3350 Programmable Key APP – Add number from Contacts

- The added numbers will show in the list as the figure shown below.

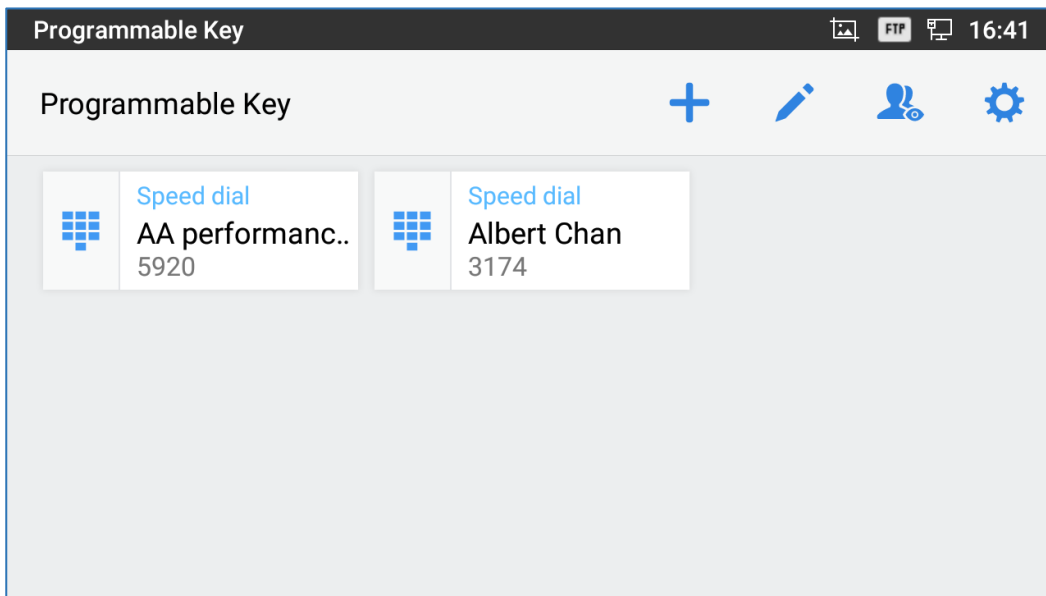

Figure 100: GXV3350 Programmable Key APP – Number List

GBX20 Extension Boards

GXV3350 also supports programmable keys with extension board (GBX20). Users can configure the programmable keys from Web GUI → Applications → Extension Boards.

For the details of how-to configuration information, please refer to GXV3350 Administration Guide.

 **Note:**

- When extension boards have been plugged in, the Programmable Keys Applications is disabled, and the account widget will not show any information of programmable keys.
 - If you want to reuse the Programmable Keys Application and others, please plug out the extension boards.
-

GXV3350 SETTINGS

Users could access the GXV3350 Settings by tapping on the icon  .

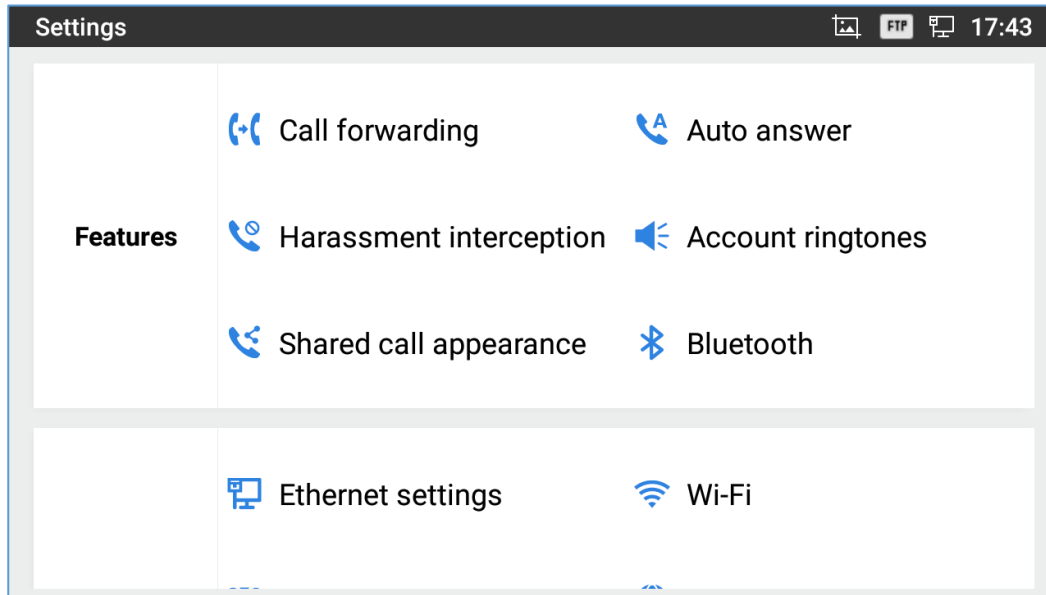

Figure 101: GXV3350 Settings

Users can find all the features and options that require configuration. Please, refer to the following table to have a clear idea about all the options available under this section:

Features	<ul style="list-style-type: none"> • Call forwarding • Harassment Interception • Shared Call Appearance (SCA) • Auto Answer • Account Ringtones • Bluetooth
Network	<ul style="list-style-type: none"> • Ethernet Settings • VPN • Proxy Settings • Wi-Fi • General Network Settings • Tethering & Portable Hotspot
Basic	<ul style="list-style-type: none"> • Sound • Language & Keyboard • Display • Date & Time • Security Settings • Peripherals

	<ul style="list-style-type: none">• Accounts• Power Information• Reboot the phone
Apps	<ul style="list-style-type: none">• Application Management• Default Application• Notification Center
Advanced	<ul style="list-style-type: none">• Account Settings• System Updates• Syslog• System Security
Status	<ul style="list-style-type: none">• Account Status• Network Status• System Info• Storage Status



HARASSMENT INTERCEPTION

The GXV3350 has blacklist support for users to manage incoming calls. To access blacklist, tap on “Settings” icon then under “Features”, access “Harassment Interception”.

Blocked Contacts

The blocked Contacts are the contacts that were added to the blacklist, the GXV3350 will block any calls coming from these contacts. To show the blocked contacts tap on Blacklist from the Harassment Interception page.

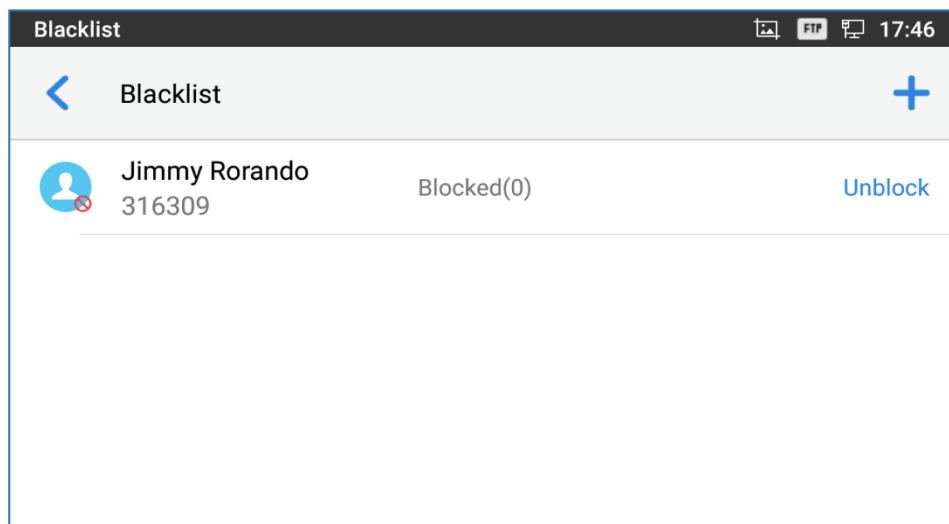

Figure 102: List of blocked contacts

Block History

To show the history of blocked contacts/numbers, tap on call history from home screen then on “Blocked”.

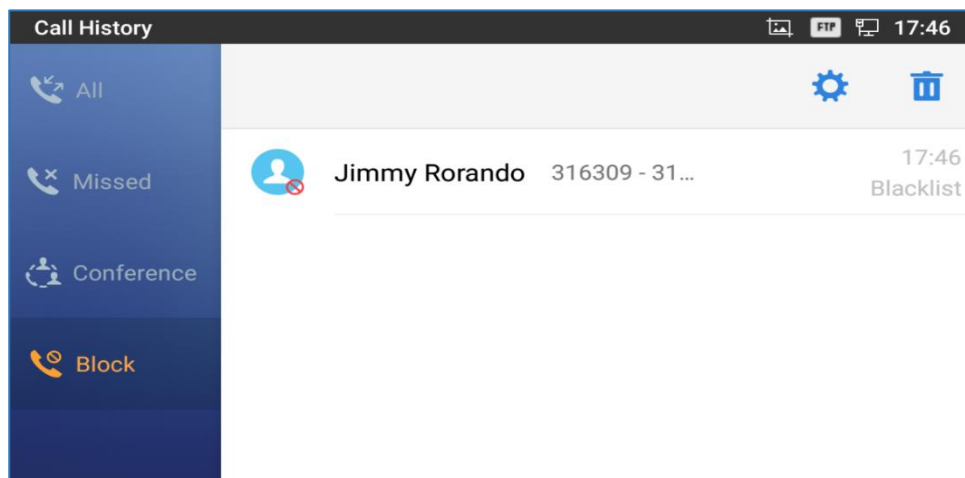



Figure 103: Block History

Delete Block History

1. In the block history, tap on the recycle bin icon 
2. Confirm the deletion of the complete blocking record by pressing “OK”

Edit Blacklist

Tap on Blacklist under the Harassment Interception Menu to show the blacklisted contacts

- **Add number to blacklist**

1. Tap on  to start adding new entry to the blacklist. The blacklist can be added manually, from contacts, or from call history.

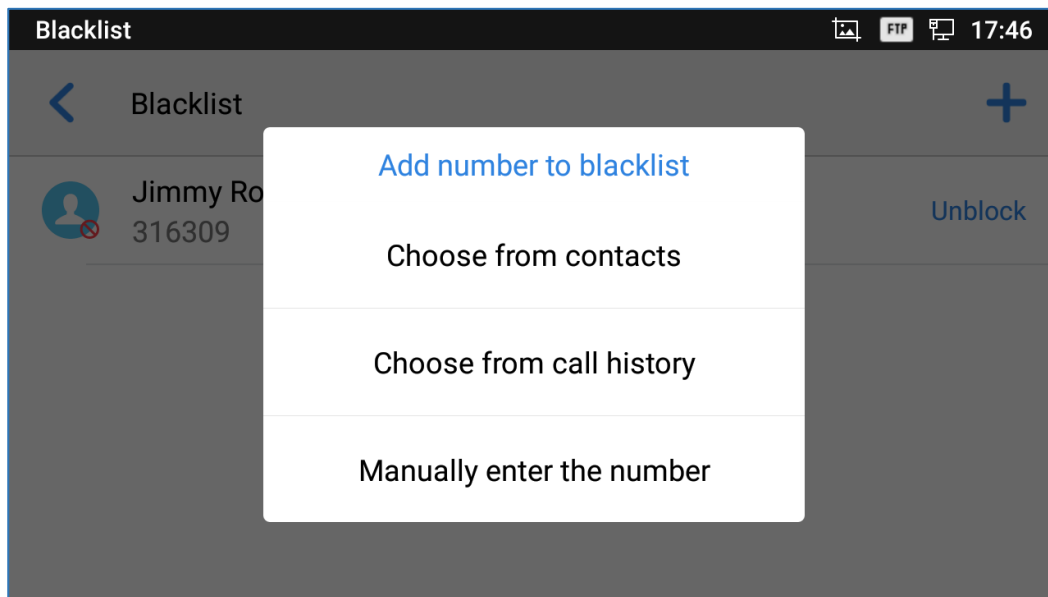

Figure 104: GXV3350 Blacklist - Add Number to Blacklist

2. The following figure shows manually adding number to blacklist. Once **Manually add** option is selected, a window will be prompted for users to enter the phone number in the first field and name/note in the second field (optional). Tap on **OK** to finish the adding operation.

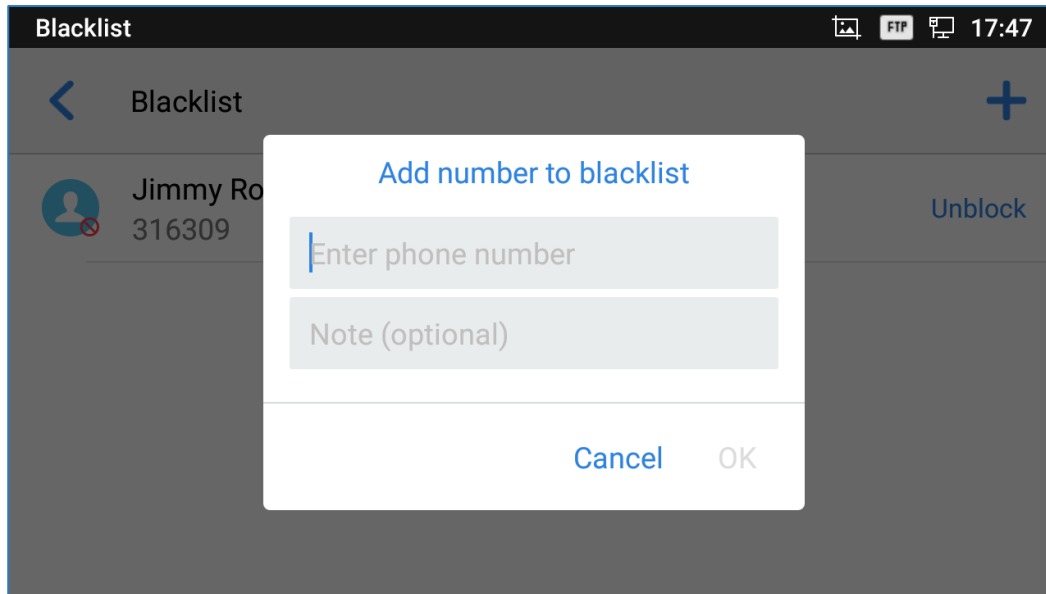

Figure 105: Manually Add Number to Blacklist

- **Edit Blacklist**

1. In the blacklist, touch and press the entry for about 2 seconds a prompt allowing changing the name/note is displayed
2. Change the name/note.
3. Tap on OK once done.

- **Delete Blacklist**

Users can Delete/unblock contacts from the black list using two methods:

1. From the black list menu press on “Unblocked” to no longer block the calls from coming from this contact.
2. From the contacts menu, long press on the contact and press “Remove from Blacklist”.

Intercept Anonymous calls

The GXV3350 gives the possibility to intercept anonymous calls for each account registered:

1. Enter the harassment Interception Menu.
2. Check **Intercept Anonymous Calls** as shown on the figure below.
3. Check the account to apply the interception.

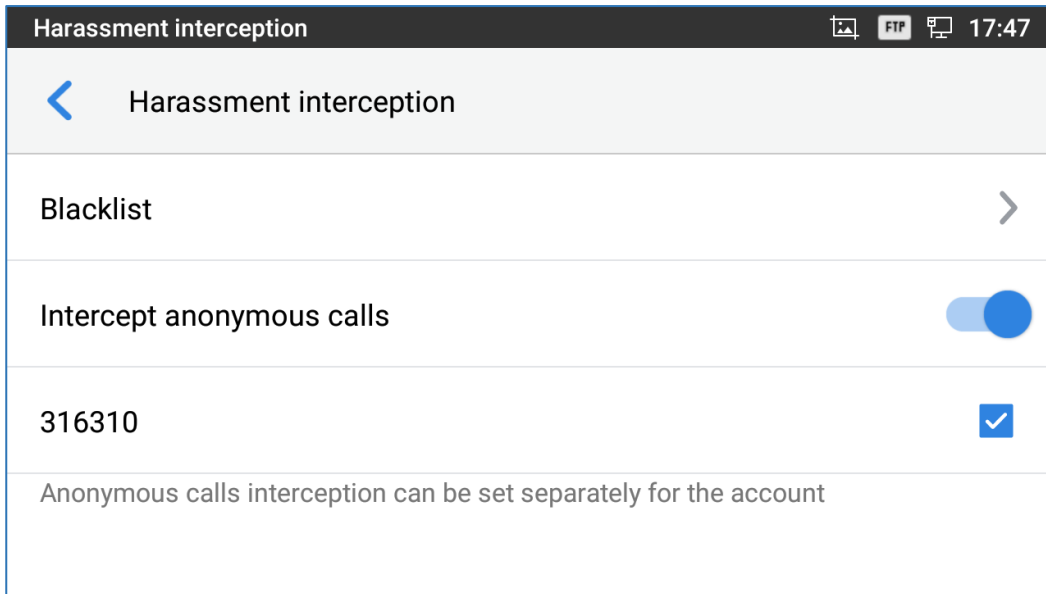



Figure 106: Intercept Anonymous Calls

CALL HISTORY

The GXV3350 supports local Call history. Tap  on idle screen to access Call history. The following figure shows the call history on the GXV3350.

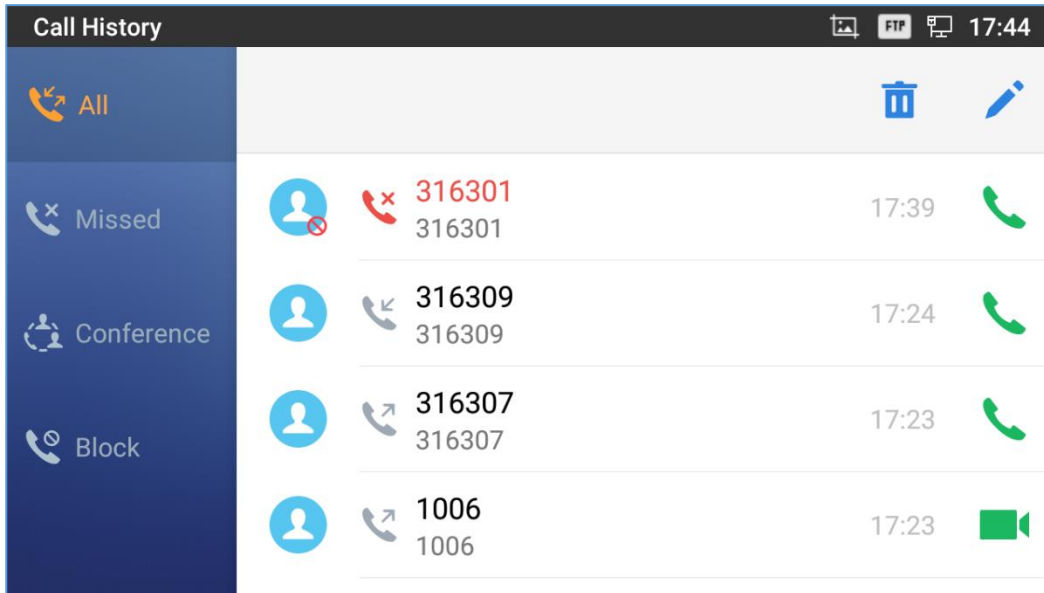





Figure 107: GXV3350 Call History

Local Call History

There are four different categories in the local call history. Users could tap on the icon on the top menu to access the corresponding call logs:

-  All
-  Missed
-  Conf History
-  Block (if any)

Dial Out from Call History

Tap on one of the call history entry to call this number directly. The phone will use the same account as the call log when dialing out.

Call History Options

- Touch and press the call history entry for about 2 seconds until more option window pops up
- Users can edit this number before calling, add this number to contacts, add this number to balcklist etc...

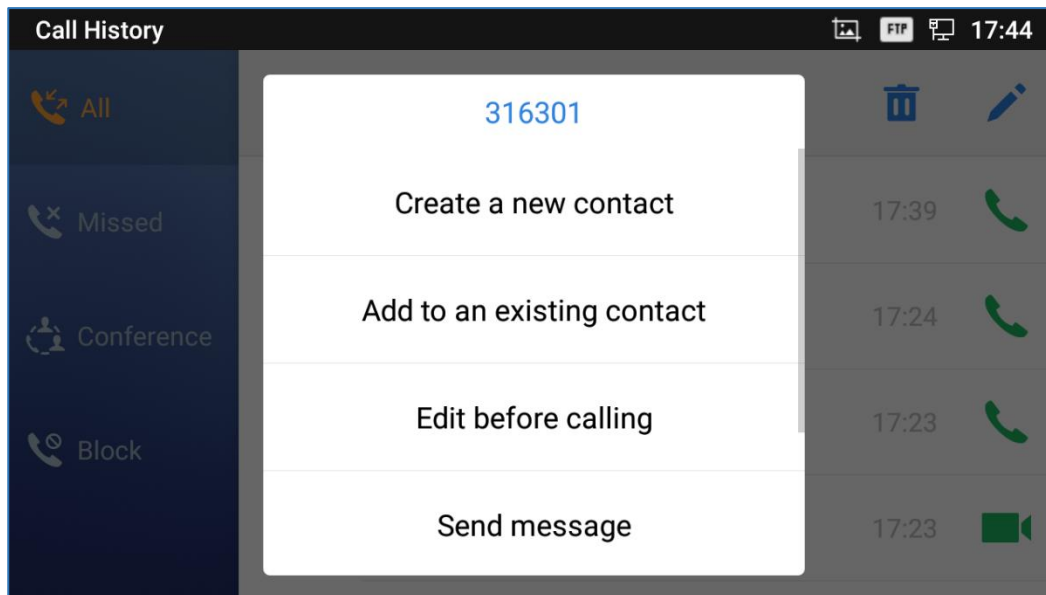



Figure 108: GXV3350 Call History – Options

Delete Call History



- **Delete the entire call history**

Users can delete the complete call history by pressing the  directly afeter accessing the call history page.

- **Delete a single call history entry**

Users can delete a single call history entry by pressing the entry for about 2 seconds to bring up the options then select Delete call history.

- **Delete multiple call history entries**

- Press on  the top right corner of the screen and select the entries to be deleted
- Tap on  to delete the entries.

Call History Details

For each call history entry, users could tap on the entry to access the details.

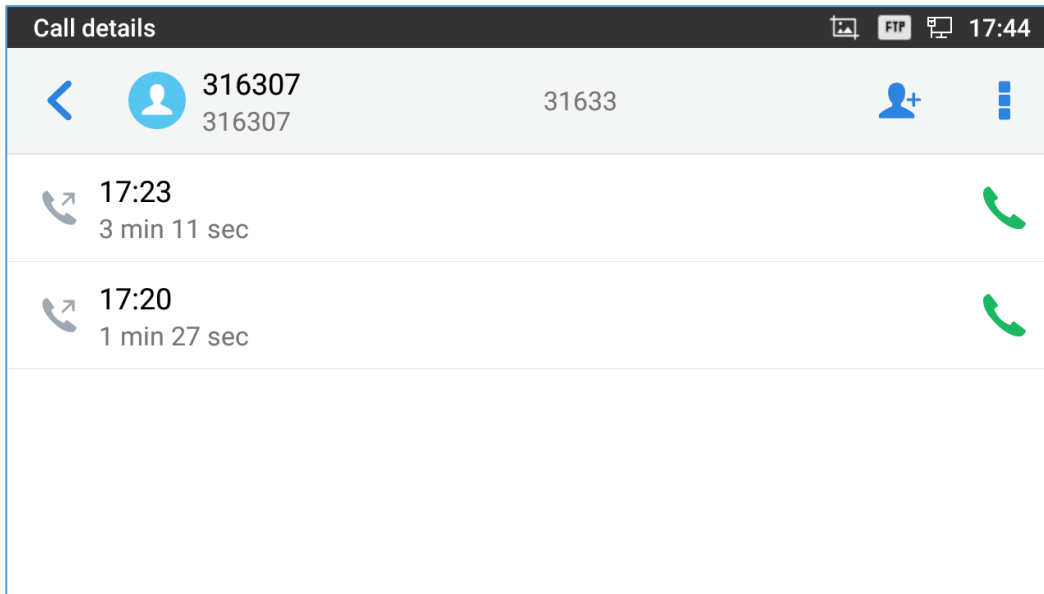







Figure 109: GXV3350 Call History - Details

Users could find the following call details by tapping on the entry:

- **The Call date:** the time when the call was initiated.
- **The Call duration:** The period of time when the call was in progress.
- **The type of the call:** Specifying if the call was a Video or an Audio Call.

Note: Call details under conference history include the previous details of the conference and for each one of the participants.

The following operations could be done:

-  Dial out this number directly.
-  Bring up dial screen with the call history number. Users could edit the number before dialing out.
-  Add to Blacklist
-  Delete the entry.
-  Options , "Create a New Contacts", "Add to an Existing Contact".

SMS

The GXV3350 has built-in SMS application to send/receive message, if the SIP server and the other party support SMS message. Users can create, edit draft, delete and check the storage status of SMS.

Tap on  from the phone's desktop to launch SMS application.

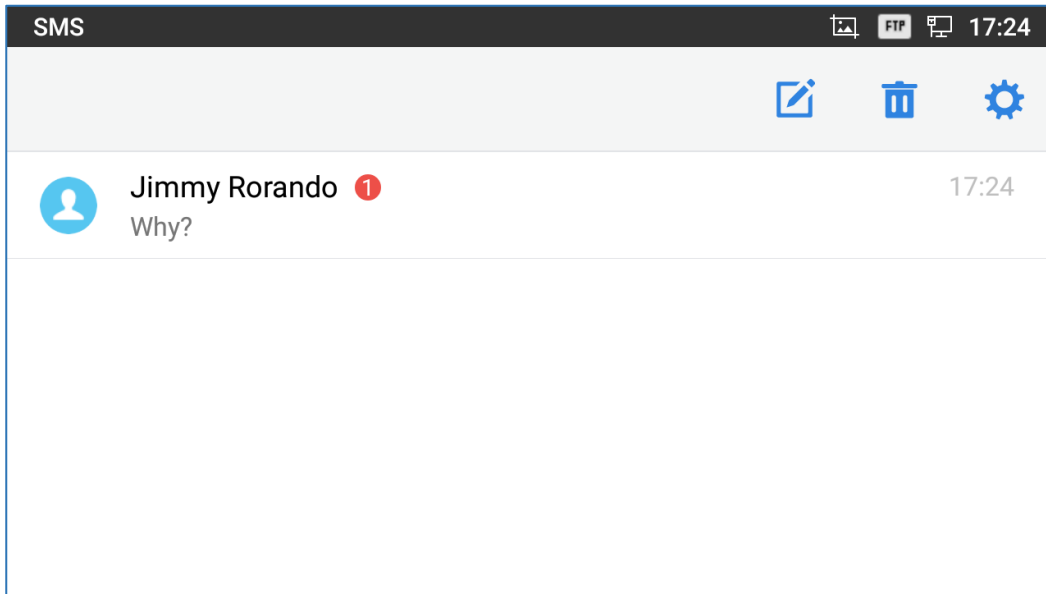

Figure 110: GXV3350 SMS Message

View SMS

On the SMS list screen, tap on one of the message to view the SMS details.

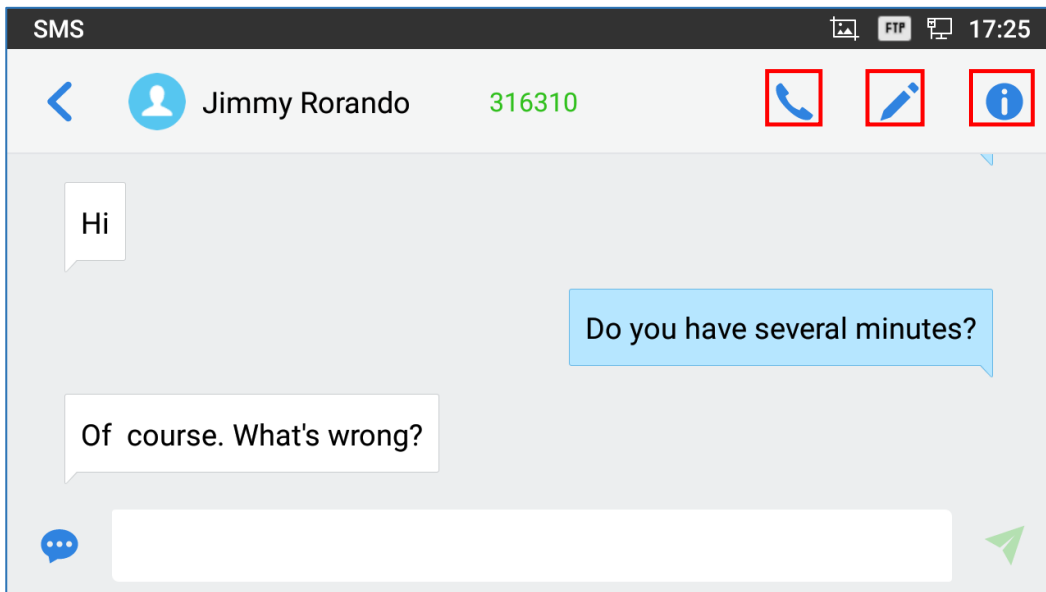





Figure 111: View SMS Dialog

- Users can press on  in order to make a call to the account's number on that conversation.
- Users can press on  in order to “delete”, “lock”, “unlock” or forward a message or a batch of messages from the conversation.
- Users can press on  in order to add the number as a contact in the GXV3350.

Create New SMS

Tap on  in SMS application to start composing a new message.

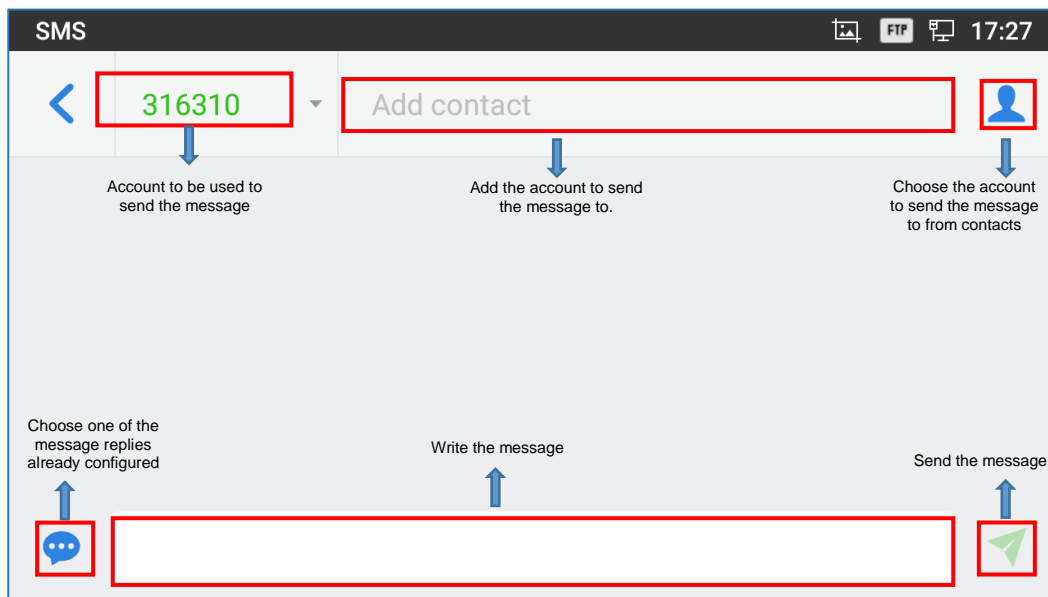



Figure 112: Create a New SMS

1. Select account to send the message from. (**Note:** Only registered accounts will be shown on the selection drop-down list, if you cannot find your account then make sure it's registered).
2. Enter the account number to send the SMS message to:
 - Add number to send the message to.
 - Enter the Number/Name of an existing contact to send the message.
 - Users could also select contact from GXV3350 Contacts by tapping on “Contacts” icon  on the upper right of the page.
3. Input content: Enter the message content on the bottom field of the screen. Tap on "Done" from the Keyboard once finished.
4. Send message: Tap on the arrow icon when you are ready to send the message out.

Delete SMS

1. Users can press and hold one SMS message in a conversation for about 2 seconds until a prompt appears where “Delete” can be pressed in order to delete the chosen SMS message.



2. In order to delete one conversation, users can press and hold the conversation for about 2 seconds until a prompt appears where “Delete” can be pressed in order to delete the chosen SMS message.
3. Users can delete a batch of conversations by pressing on , then the conversations can be selected in order to delete them by pressing the same icon.

SMS Settings

Users can verify the SMS Settings by pressing on “Settings” icon  from the conversations screen.

- **Storage Status:** The SMS app supports up to 1000 messages, “storage status” helps users to verify the current number of messages on the GXV3350 and the storage space that still available.
- **Enable Quick Reply:** Enable this feature in order to automatically send a quick reply when an incoming call is rejected.
- **Choose a quick reply message:** Users can add more quick reply messages by clicking on , and choose the one that will be used and sent automatically when an incoming call is rejected.

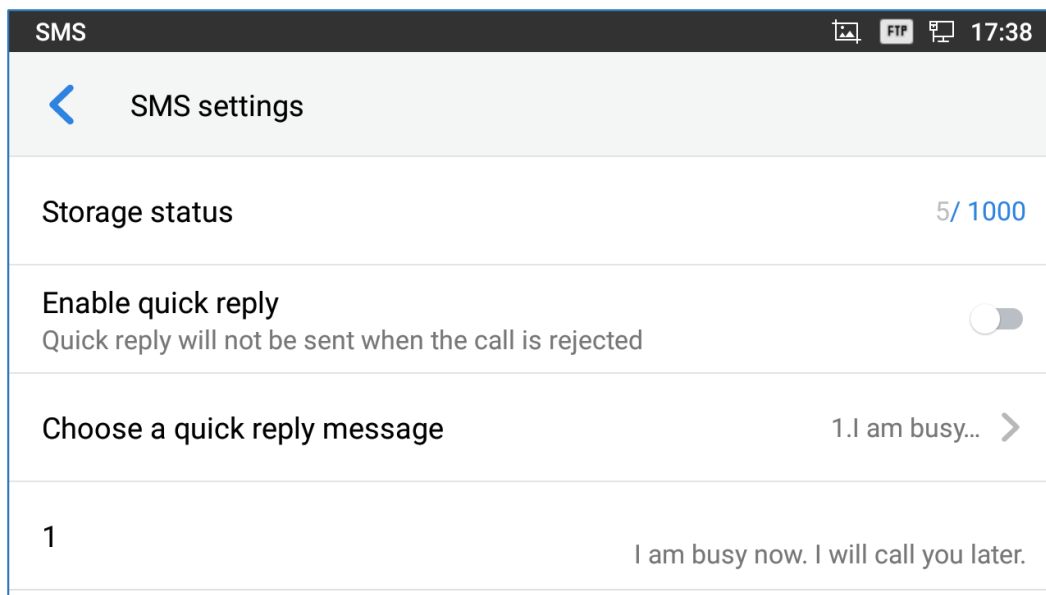

FILE MANAGER

File Manager is a tool that allows users to delete, move, copy/past, send and rename files. It helps users to access and manage files in local storage as well as external storage devices (e.g, USB flash drive). Tap



on the phone's menu or desktop to launch File Manager application.

Files Operations

Copy and Paste Files

Follow the steps below to copy and paste a file on the GXV3350:

1. Open file manager and navigate to the directory of the file to be copied. Touch and press on the file for about 2 seconds until the options window pops up then press Copy.
2. Select the location to which you want to paste the file and press on  .

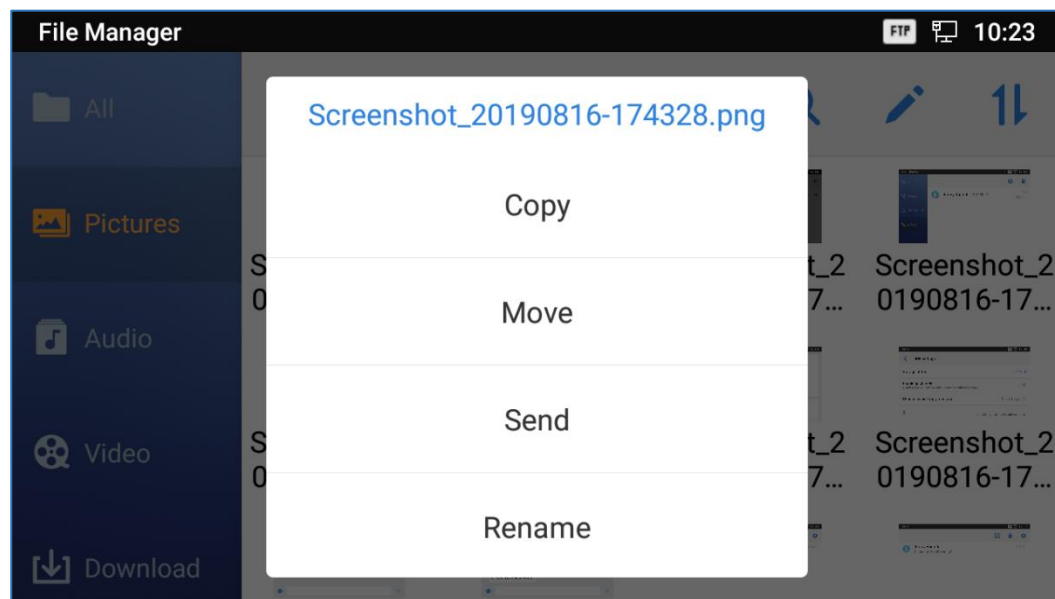





Figure 113: GXV3350 File Manager – Copy File

Or

1- Press  on the top right corner of the screen and select the files to copy

2-Tap on  to copy the files selected

3-Select the directory to which you want to paste the files then press  .

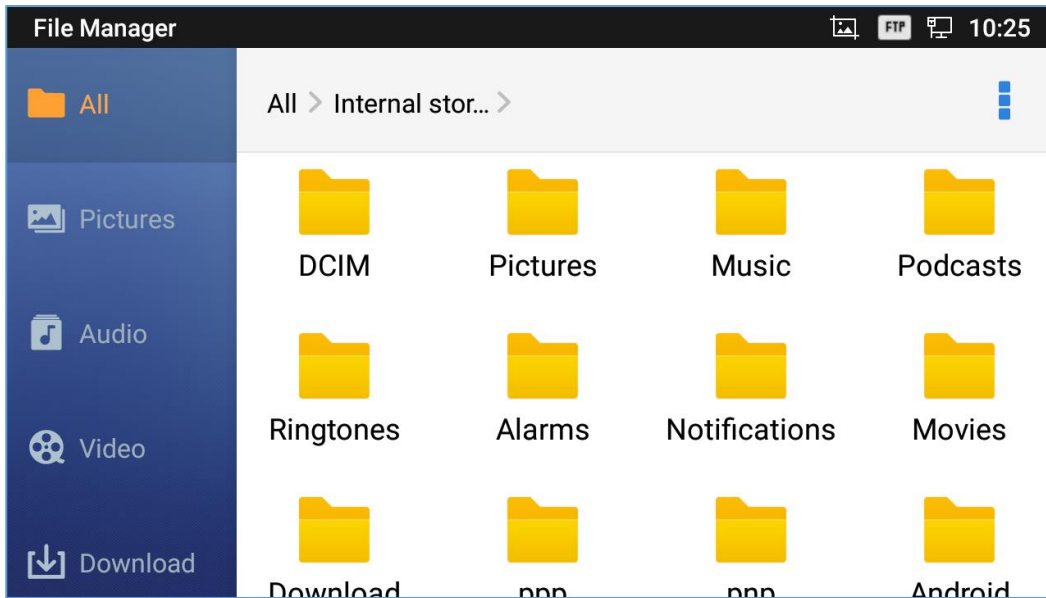



Figure 114: Paste File

Move Files

The steps to move a file are similar to the steps to copy/paste a file. The difference is once the file is moved, the file will not be kept in the source folder. Follow the steps below to move a file on the GXV3350.

1. Open file manager and navigate to the directory of the file to be moved. Touch and press on the file for about 2 seconds until the options window pops up then press Move.

2. Select the location to which you want to past the file and press on 

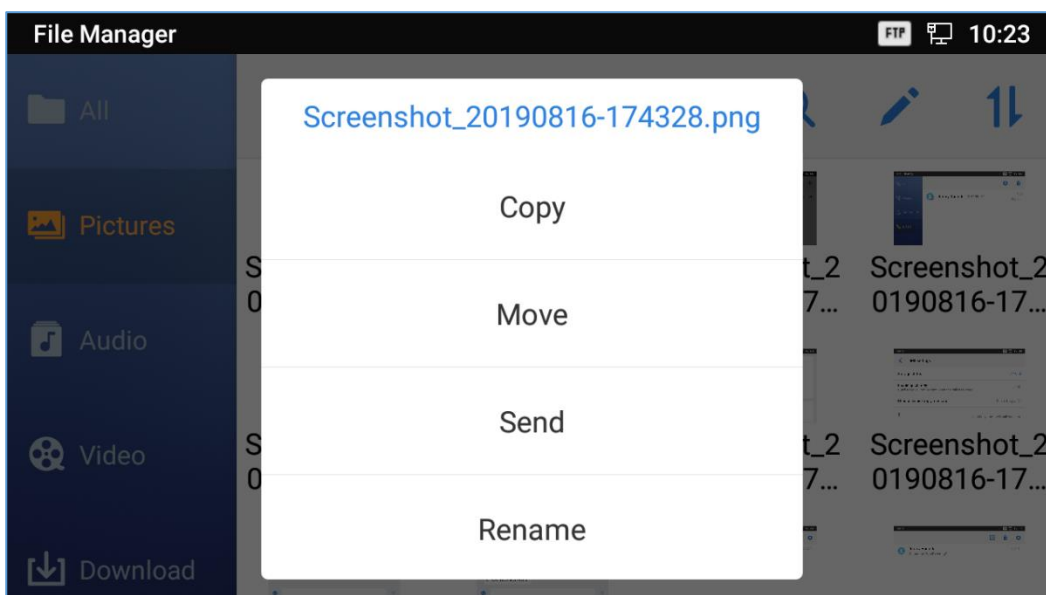

Figure 115: GXV3350 File Manager - Move



Send Files

The users can send a file via Bluetooth. Please make sure Bluetooth is turned on and connected to the Bluetooth devices. Otherwise, users will be directed to set it up before the file can be sent out.

To send a file:

1. Open file manager and navigate to the directory of the file to be sent over. Touch and press on the file for about 2 seconds and press send
2. Select the Bluetooth device to which the file will be transferred

Or

1. Open file manager and navigate to the directory of the file to be sent over then press on 
2. The check boxes will appear then check the files to be sent over
3. Press on  to send the selected files via Bluetooth then choose the Bluetooth devices to send the files to.

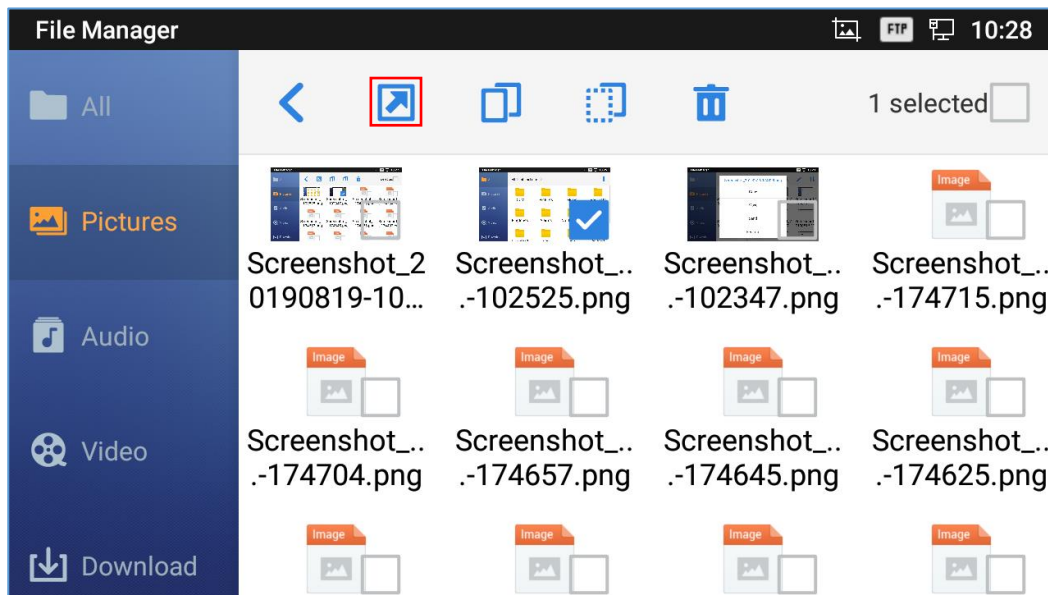



Figure 116: GXV3350 File Manager - Options

Delete Files

1. Open file manager and navigate to the directory of the file to be deleted. Touch and press on the file for about 2 seconds until more options appear.
2. Scroll down and select “Delete”

Or



1. Open file manager and navigate to the directory of the file/files to be deleted the click on 
2. The check boxes will appear then check the files to delete
3. Press on  to delete the files selected
4. Tap on **OK** to confirm

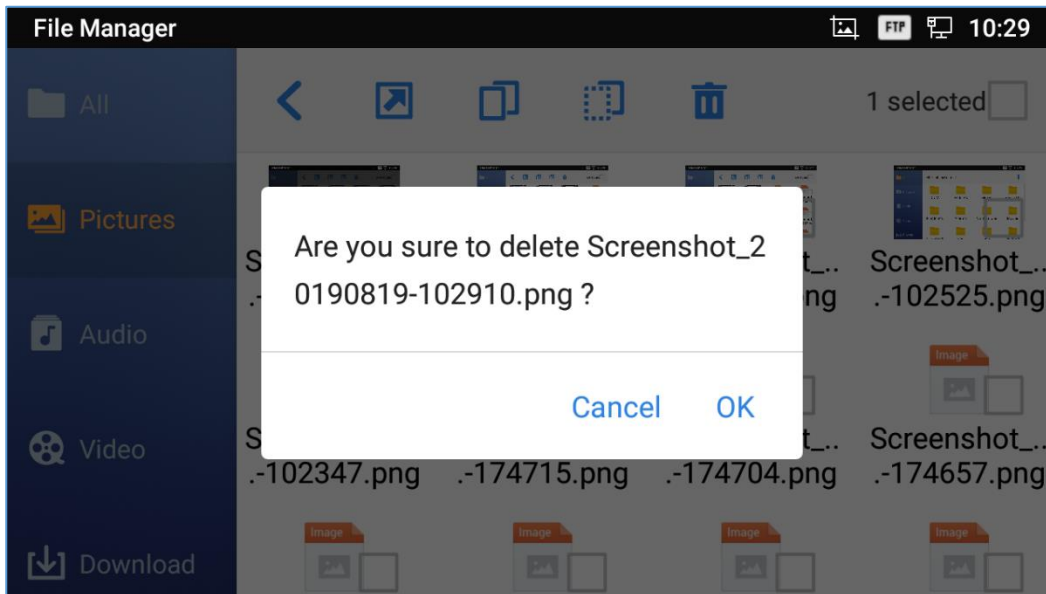

Figure 117: Delete File(s) via File Manager

Rename a File

1. Open file manager and navigate to the directory of the file to be renamed. Touch and press on the file for about 2 seconds until more options appear
2. Tap on "Rename". A new dialog window will pop up for users to enter the new name.
3. Tap on **OK**.

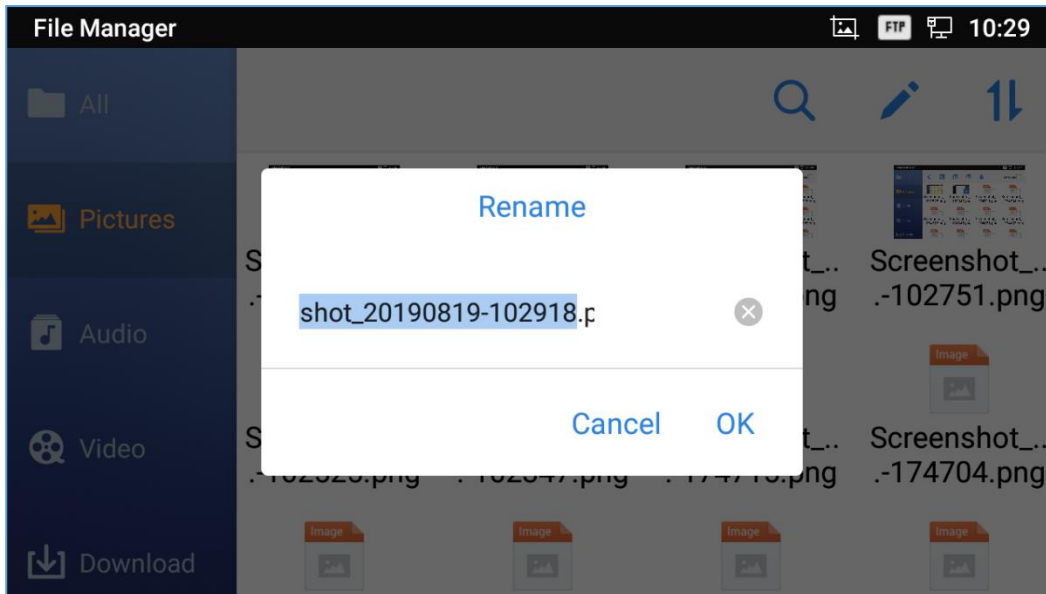

Figure 118: Rename File

File Categories

The file manager will categorize the files stored on local/external storage based on the type of files. The available categories are

- **All:** gives access to all internal storage files as well as external storage devices
- **Pictures:** contains all the pictures stored on the phone including screenshots, camera pictures and external pictures
- **Audio:** contains all the Audio file on local and external storage
- **Video:** contains all the videos stored on the phone including recorded videos from camera and videos stored on external devices
- **Downloads:** in this category the phone will list all the downloaded files such as apps, document, music, videos ...etc.

GS MARKET

The GXV3350 supports extensive amount of 3rd party Android applications. Users could install those applications from the built-in GS Market. If Google Play application is installed from GS Market, users could log in and download all kinds of applications there as well.

Tap on  at the phone onscreen menu to launch the GS Market. Users could browse, search, download and install the apps from there for tools, games and other applications.

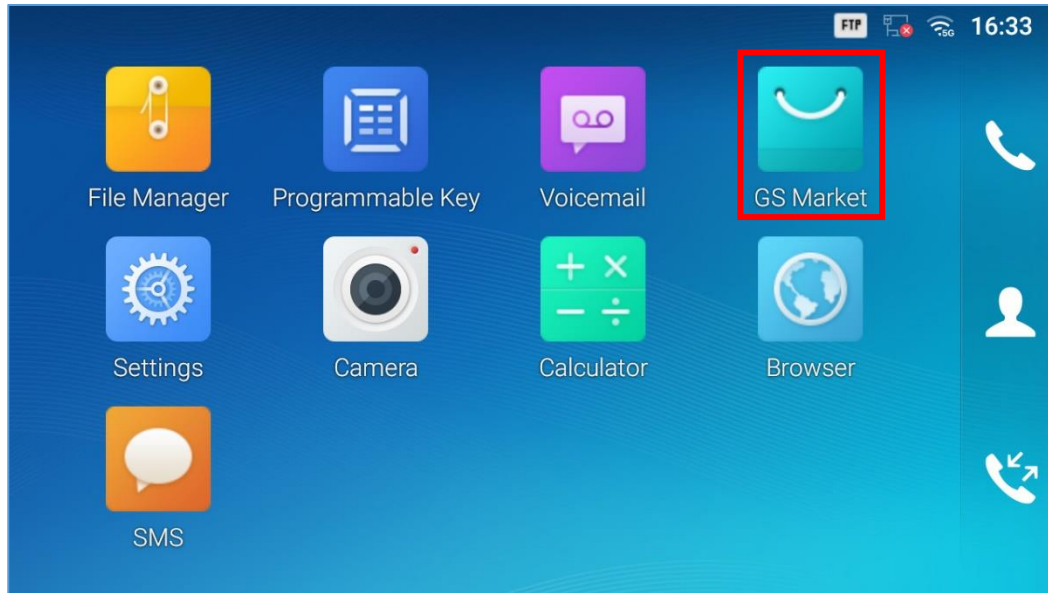



Figure 119: GS Market – Onscreen Menu

FTP SERVER

The GXV3350 supports file transfer via FTP server. Once installed, users could access the GXV3350 file system from PC. In order to access FTP Server application, go to GXV3350 application screen → File

Manager, and click on the icon .

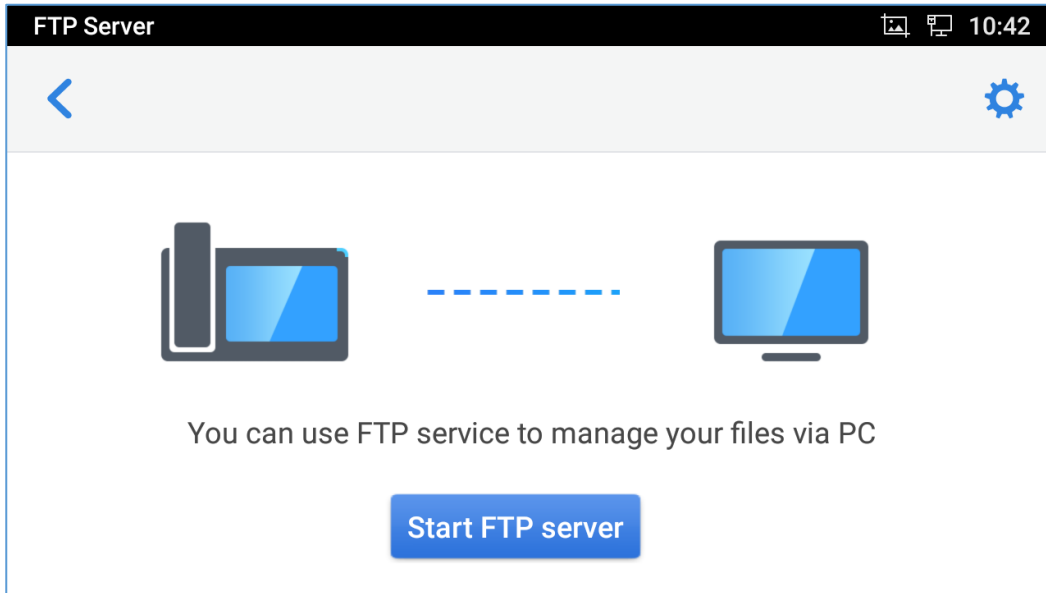

Figure 120: FTP Server – Start

Tap on "Start FTP Server" to turn the server on. The FTP server address URL will be provided on the screen.

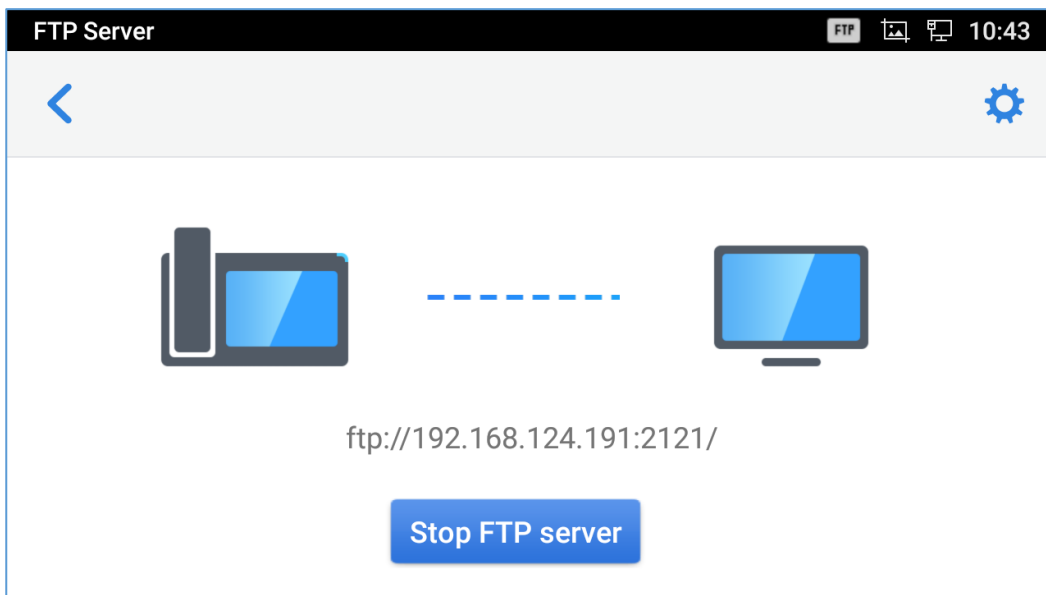



Figure 121: FTP Server – Stop

For security purpose, users could also tap on  in the above figure to set up username, password, port number and directory for remote access. By default, when the users access the ftp server from a PC, a prompt will show asking for user name and password. The default user name and password are "admin".

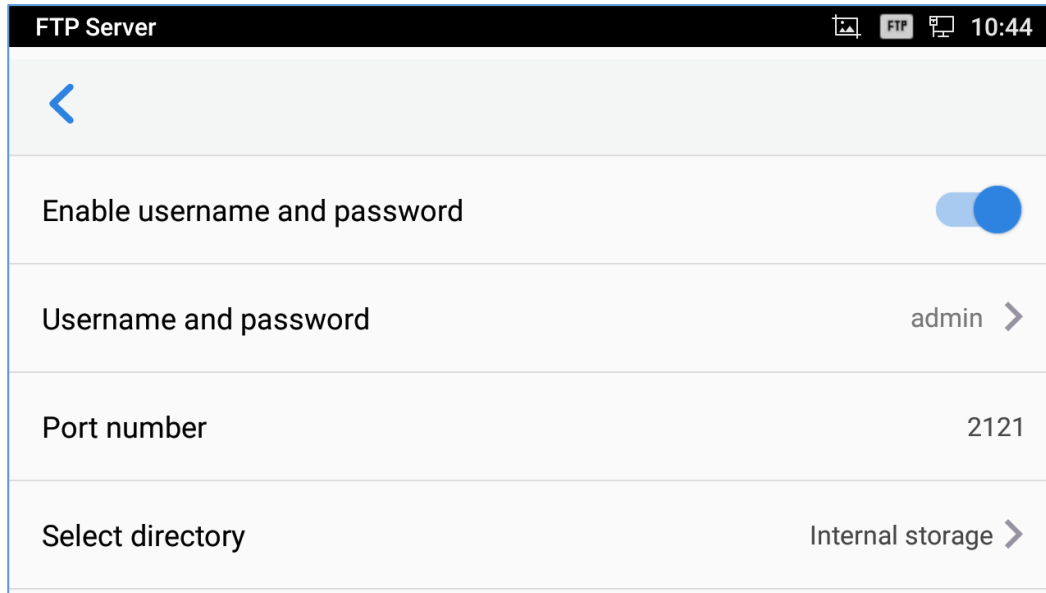

Figure 122: FTP Server – Settings

StateDetection

The StateDetection APP is as diagnosis APP that scans generally the Port and network status of the GXV3350 also includes the audio loopback test feature to check the Microphone and Speaker's state:

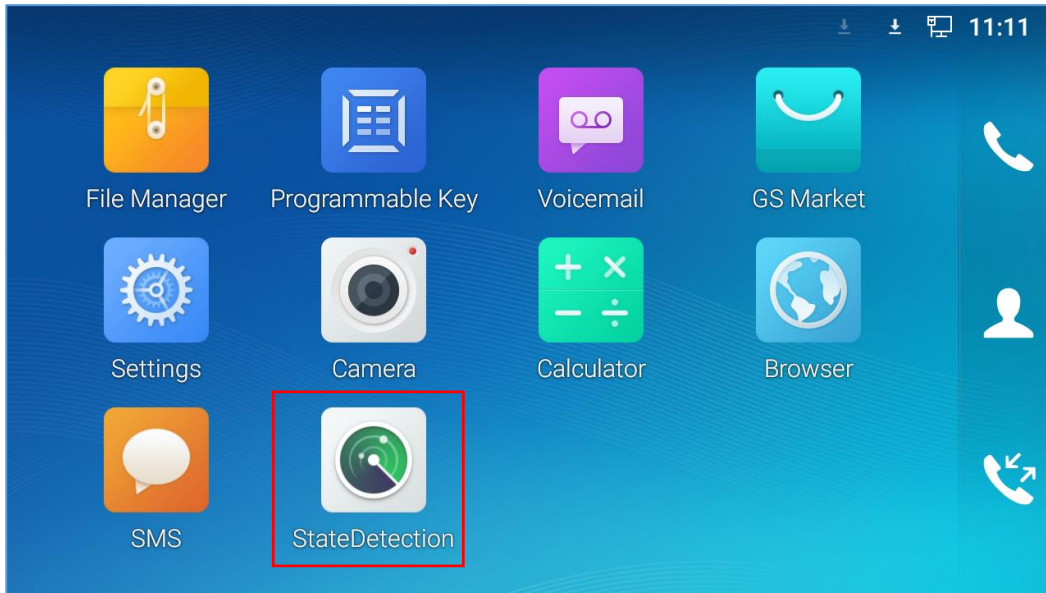

Figure 123: StateDetection APP

Tap on "Start" to turn the Ports and Network diagnosis on. The APP will then list the result of of the scan.

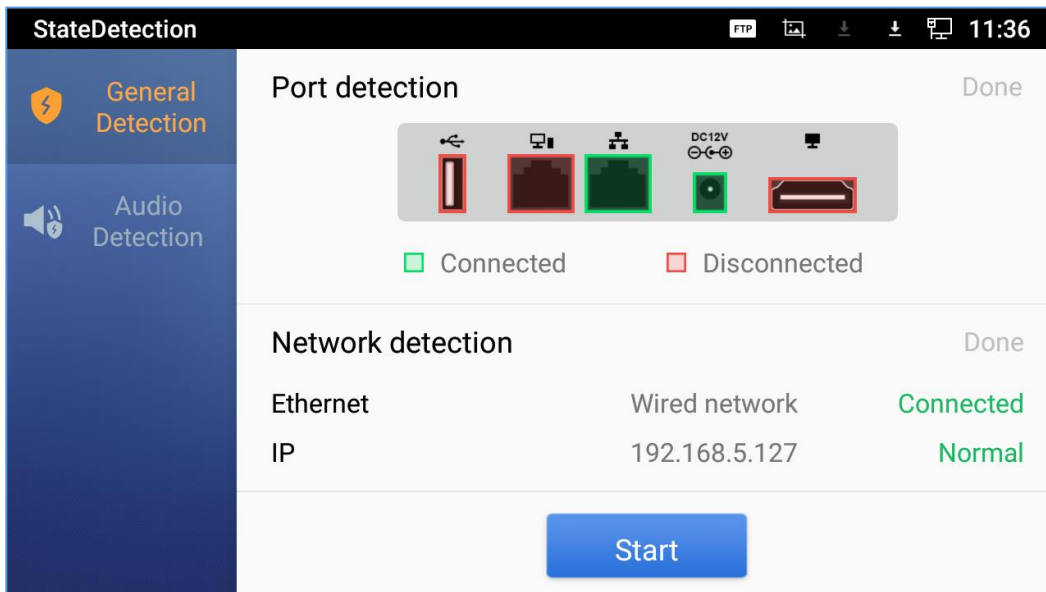

Figure 124: General Detection

To run the audio loopback test, tap on "Audio Detection" then on Start to verify if the microphone operates normally and if you can hear your voice from speaker.

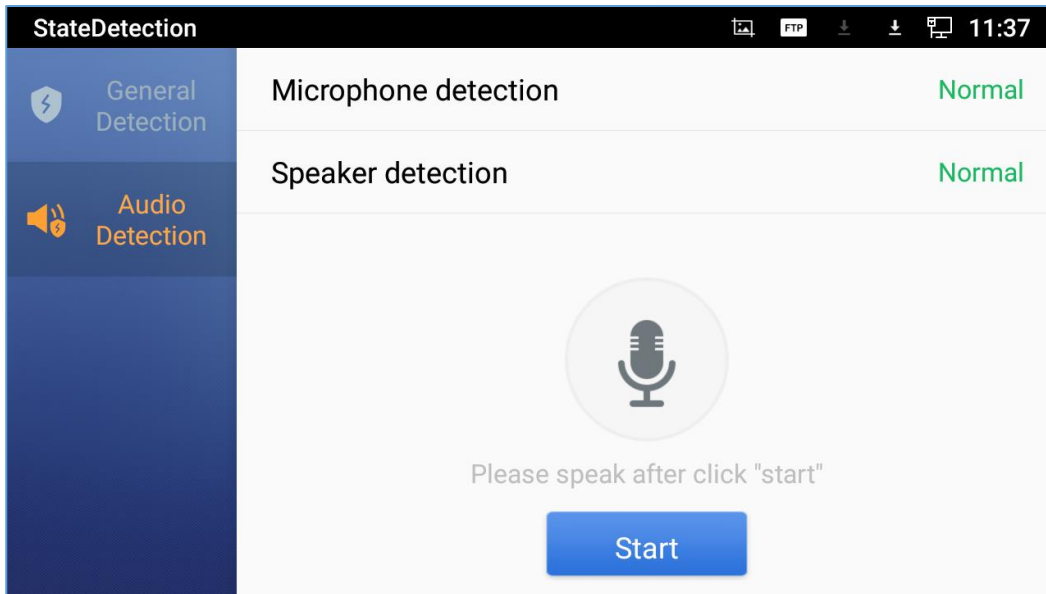



Figure 125: Audio Detection

CAMERA

The GXV3350 has built-in Camera to support taking pictures and recording videos. The camera can be used for SIP video calls or video calls via 3rd party applications.

Note: During SIP video calls or video calls via 3rd party applications, the camera cannot be accessed to take pictures or videos.

To access Camera to take pictures and videos, tap on Camera icon  on idle screen.

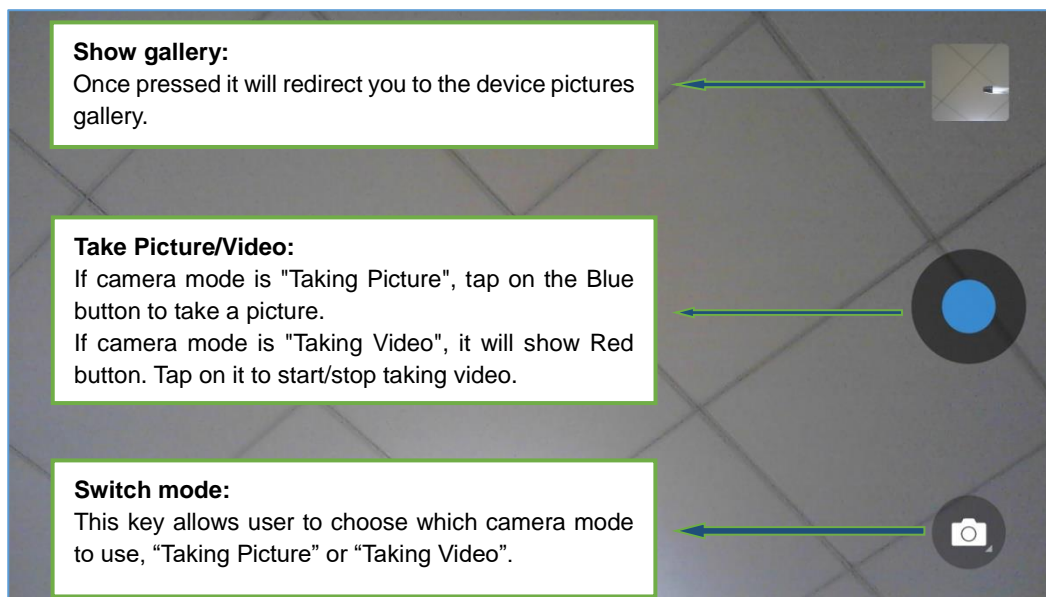





Figure 126: GXV3350 Camera

Take Picture

1. Press  to take picture.
2. The captured picture can be accessed under **File Manager** → **Internal Storage** → **DCIM** → **Camera**.
3. To view the last taken pictures, swipe from right to left on camera screen.

Record Video

1. Swipe from left to right on camera screen or press menu button, then tap on  then type on  to select the video mode.
2. Tap on  to start recording.
3. The recorded video can be accessed under **File Manager** → **Internal Storage** → **DCIM** → **Camera**.

4. To view the last recorded videos, swipe from right to left on camera screen.

Angle Adjustment

On the back of the GXV3350 camera, users could scroll the wheel up/down to adjust the camera angle. If users scroll the camera all the way up until the icon  shows up on the status bar of the screen, the camera is turned off.

Gallery

The GXV3350 has built-in Gallery for users to view pictures and play videos from GXV3350 internal storage. Users could also perform basic editing tasks on pictures under Gallery page.

To access the recently taken pictures or recorded videos, click on the circular key on the right top corner of the camera screen.

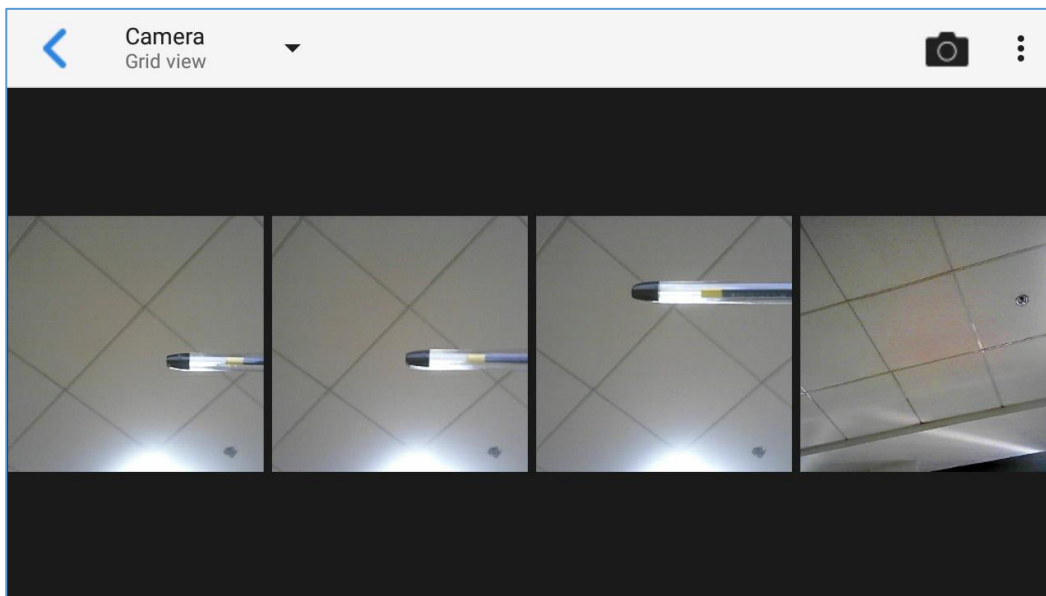



Figure 127: Recent pictures and videos page

On this page, users have the ability to perform operations, such as:

- Tapping on  button to share the file via Bluetooth or a 3rd party application.
- Tapping on  button to edit and customize pictures. Users can add filters, crop, rotate pictures... etc.

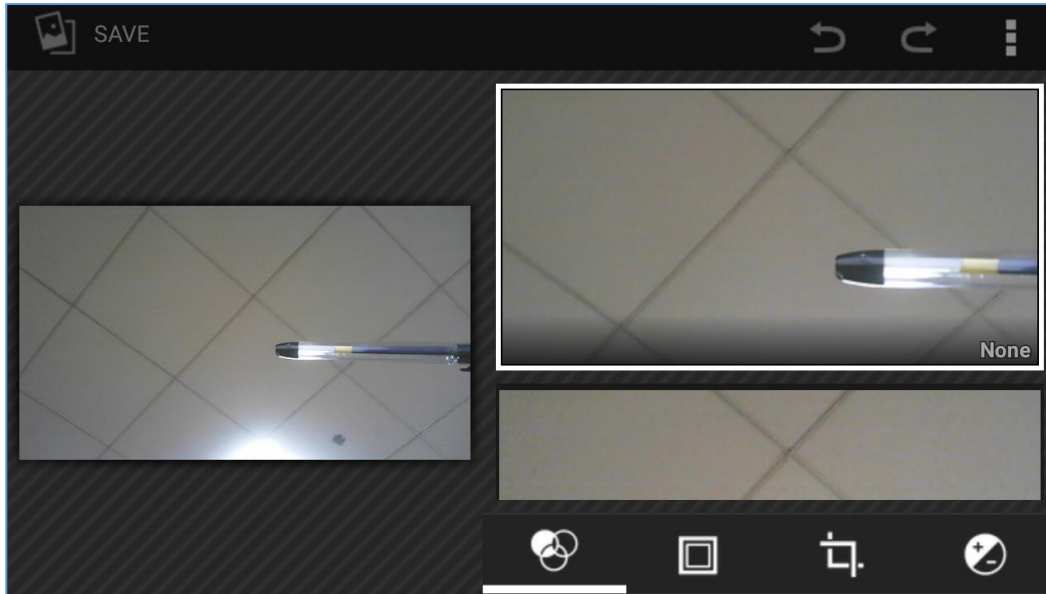

Figure 128: Edit picture

Note: Videos cannot be edited from the gallery

- **Gallery page**

To access the Gallery, open the camera click on the square key on the right top corner of the camera screen.

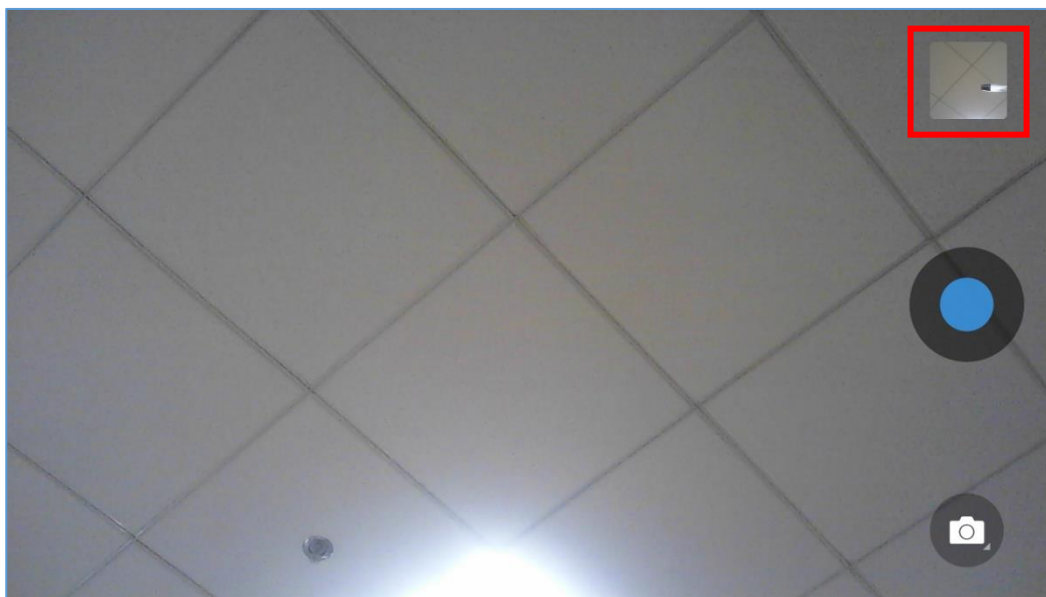

Figure 129: Access to the Gallery

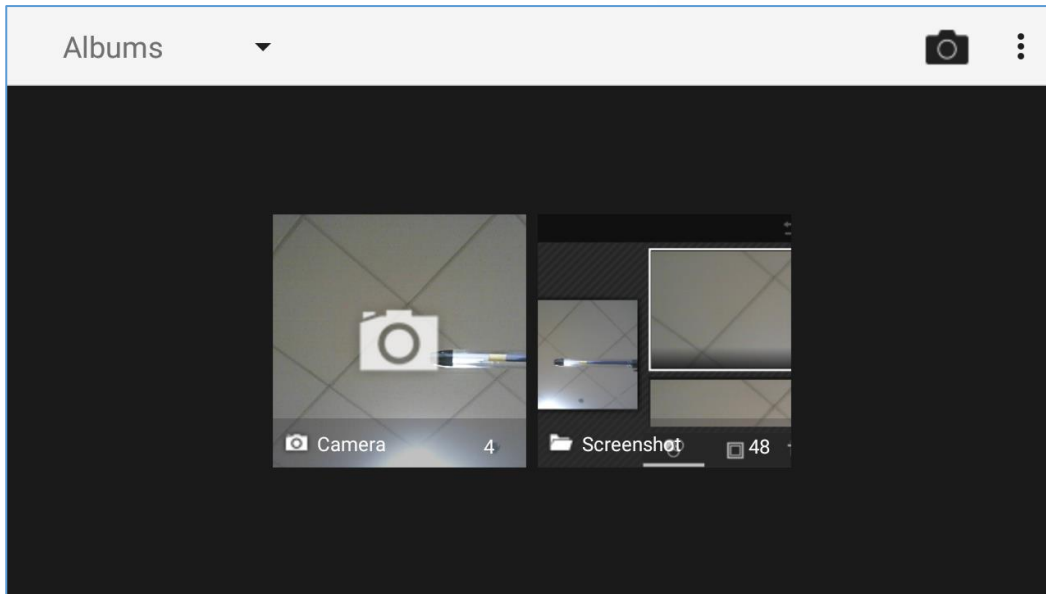



Figure 130: GXV3350 Gallery

On this page from the upper left corner, users can sort the pictures and videos by Album, Location or Time.

- **View Pictures**

Access one group of pictures and videos and select "Grid View" or "Filmstrip View" from upper left corner of the screen to set view mode of the pictures. Tap on a specific picture to view the picture in full screen.

- **Pictures Options**

When the picture is displayed in full screen, press the Menu button . A list of options will be available for users to select, including "Delete", "Slideshow", "Edit", "Rotate left", "Rotate right", "Crop" or "Set Picture as", etc.

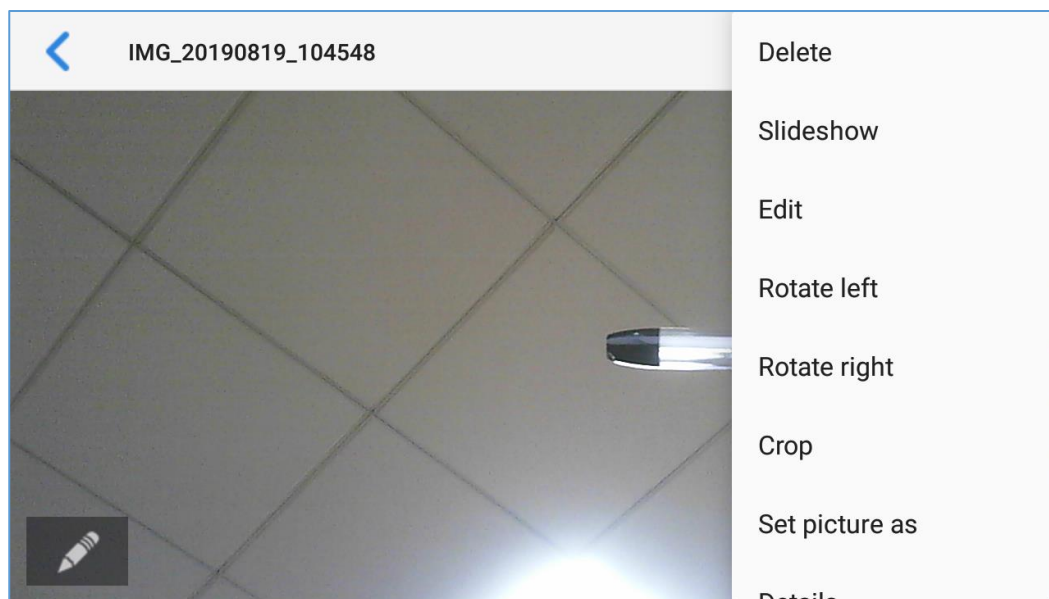



Figure 131: GXV3350 Gallery - Picture Options



- **Take picture/video**

Tap on  on the upper right of the Gallery page to start taking pictures or videos using the GXV3350 built-in camera.

- **Select multiple pictures**

Touch and press on one of the pictures for about 2 seconds until the picture is highlighted in blue.

Tap on other pictures to select multiple pictures. On the upper right of the Gallery screen, users can tap

on  to share the pictures via Bluetooth, tap on  to share the pictures via a third party

application or tap on  to delete the selected pictures.

Screensaver

User can set screensaver from the phone's idle screen under **Settings → Basic → Display → Screensaver**.

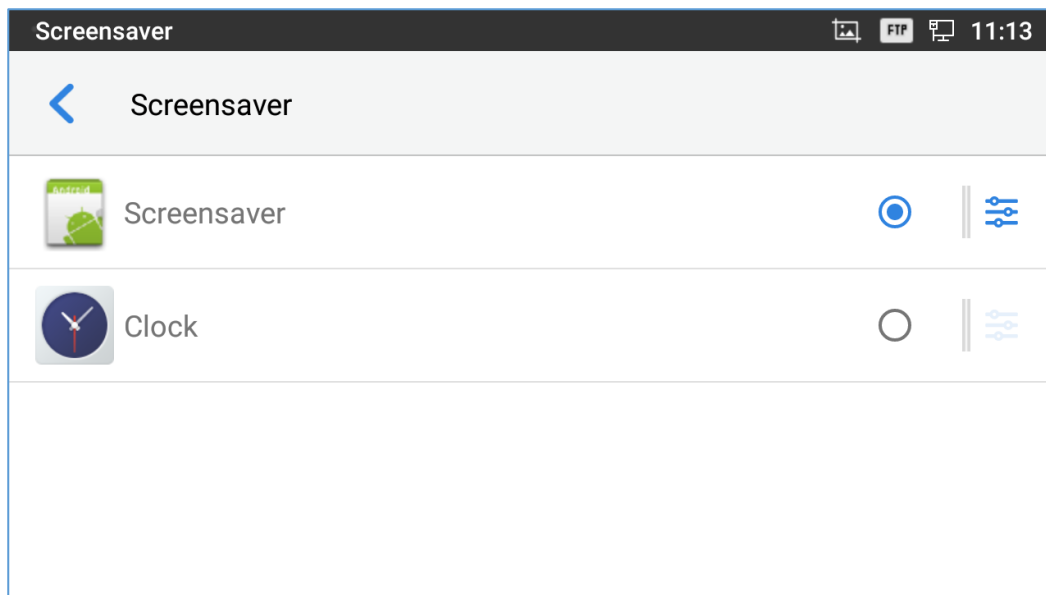



Figure 132: Screensaver settings

Users can set Screensaver to Clock or Screensaver.

- **Clock:** When setting the screen saver to Clock the phone will show a clock on the screen when the phone goes to standby mode. Press  to set the clock as Digital or Analog and Enable/Disable the Night mode.
- **Screensaver:** Users can set Screensaver from the local images, the default directory (Screensaver), or from Internal storage, or they can set a folder in a remote HTTP server to display images contained on it as screensaver. Press  to show the screensaver settings

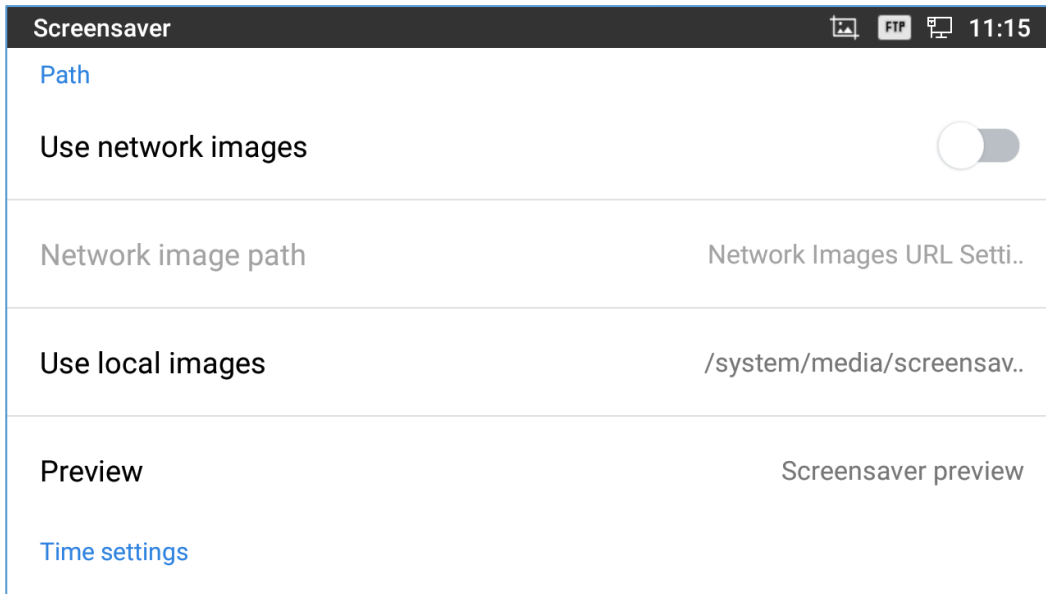

Figure 133: Use Network Images

Click on **Use network images** and set the path of the remote screensaver folder.

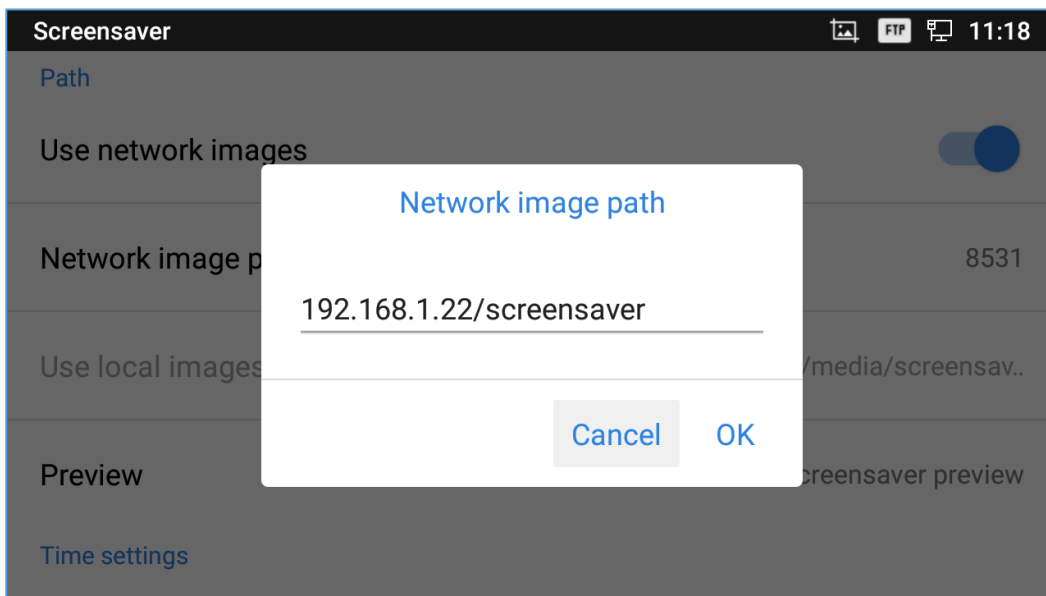



Figure 134: Network Image Path

BROWSER

GXV3350 browser could be used in a similar way as a PC-based web browser. Users can open web pages, bookmarks, view history, search ...etc. Tap  on the idle screen to launch the Browser application.

Note: The default page in the GXV3350's Browser is Google Search.

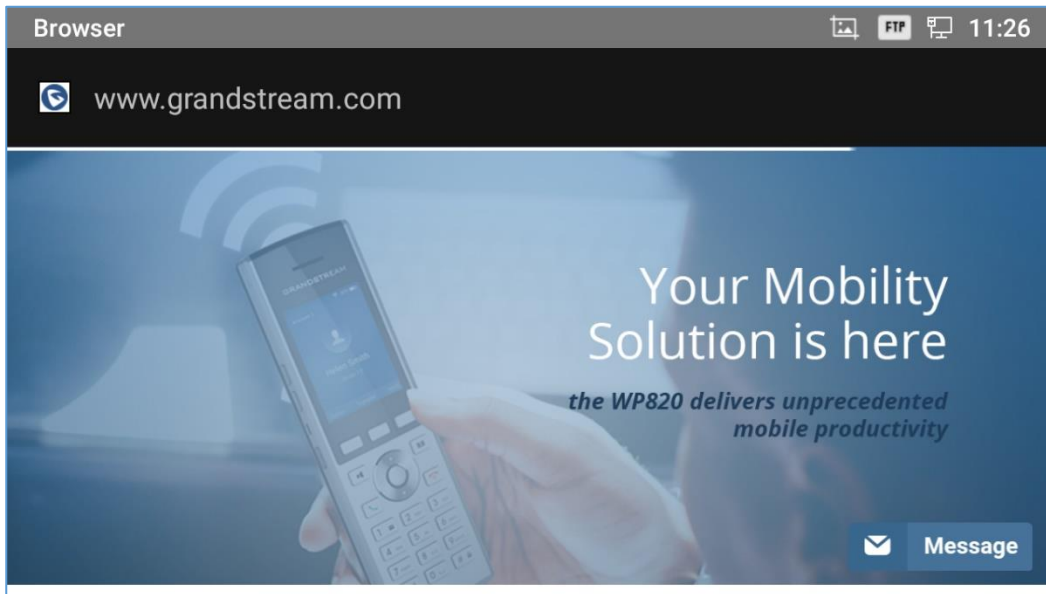



Figure 135: GXV3350 Web Browser

- Touch the screen and scroll up/down/left/right to view the web page.
- Use two fingers on the screen to pinch in or spreading out the page.
- Press the MENU button  to access more options including refresh New Tab, find on page, etc.

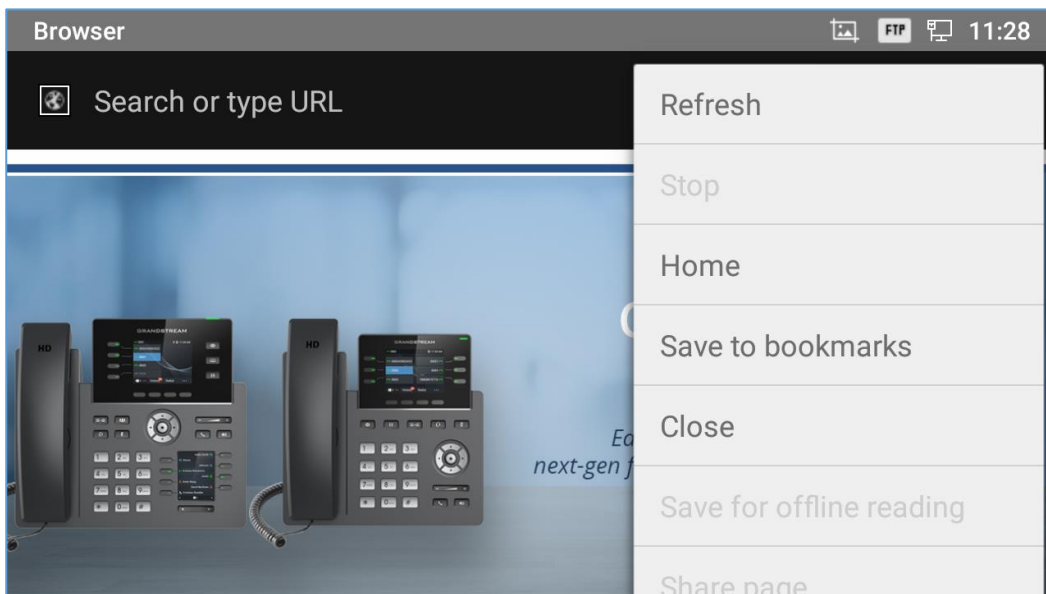

Figure 136: GXV3350 Browser Menu Options

- To open a new window, tap on the third icon  below, then tap on  icon on the right side of the tab.

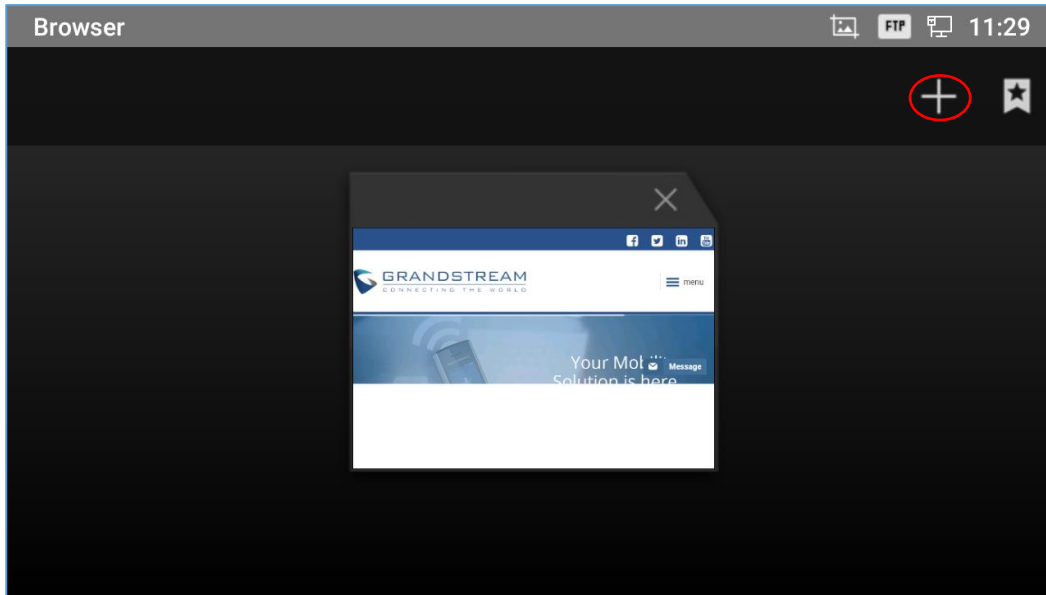



Figure 137: Open New Window in Browser

- To open **Bookmarks**, **History** and **Saved Pages**, tap the icon  on the upper right of the Browser.

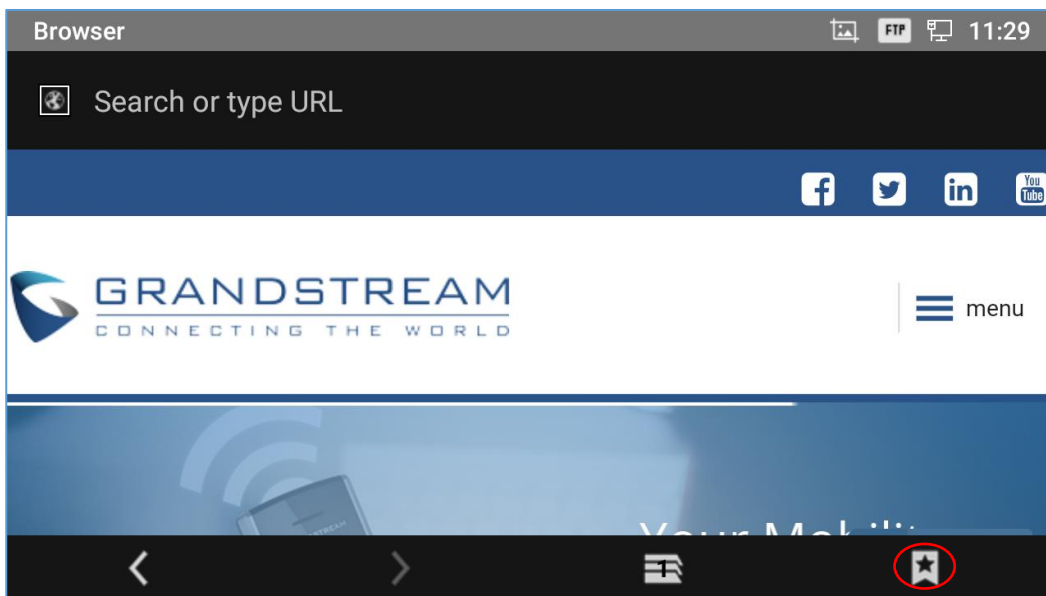

Figure 138: GXV3350 Web Browser-Bookmarks

ACTION URL

GXV3350 supports ActionURL module, and it is used to set the URL for various kinds of phone events on phone web GUI, and when the corresponding event occurs on the phone, phone will send the configured URL to SIP server. To use ActionURL module, users need to know the supported events in this module, and also added the dynamic variables of the supported events on phone web GUI. The dynamic variables of the supported event will be replaced by actual values of the phone, in order to notify the event to SIP server. Please refer to GXV3350 Administration Guide and ActionURL User Guide for the configuration details.

http://www.grandstream.com/sites/default/files/Resources/ActionURL_Guide.pdf



CONNECTING GXV3350 TO DOOR SYSTEMS

The GXV3350 offers a powerful integration with Door systems (GDS3710 Door System or others) and allows users to open the door, initiates call and gets real time audio/video stream.

In order to configure the GXV3350 with the door system from the phone side, users need to go under GXV3350 Web GUI→Value-added Service→Value-added Service. *Please, refer to the GXV3350 Administration Guide for more details about Value-added Service configuration.*

Once the configuration is done, the call from the door system is answered on the GXV3350 in full screen with the configured “Open” button to send the access password to the door system. *Please, refer to the following figure:*

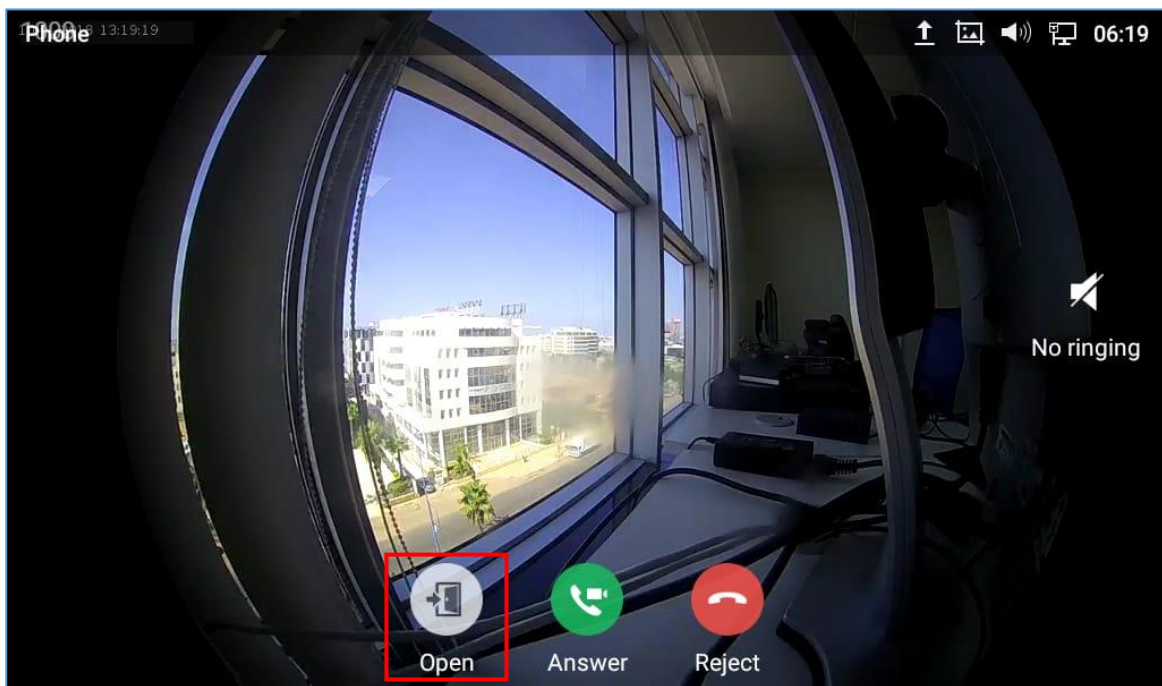

Figure 139: Incoming call from GDS3710 door system

The GXV3350 can be connected with the door system in two different ways, either using peering mode (without a SIP server) or through a SIP server. For more details, please refer to following guide describing the steps to connect the GXV3350 to GDS3710:

http://www.grandstream.com/sites/default/files/Resources/Connecting_GDS3710_with_GXV33XX.pdf

CONNECT TO NETWORK AND DEVICES

The GXV3350 supports a variety of network connections (Ethernet, Wi-Fi) and device connections, including EHS headset (Plantronics), USB and Bluetooth device. Users can connect the GXV3350 and transfer files from/to the GXV3350 using a USB connection or Bluetooth.

Ethernet

Ethernet connection is turned on as DHCP by default. If you would like to use Ethernet connection for network access, please make sure the Ethernet cable is plugged in to the LAN port on the back of the GXV3350.

To configure Ethernet settings on GXV3350 LCD:

1. Go to GXV3350's **Settings** → **Network** → **Ethernet Settings**.
2. Touch **IPv4 settings**.
3. Tap on "IPV4 Address Type" to select DHCP, Static IP or PPPoE as the address type.
 - For DHCP, save the setting and the GXV3350 should be able to get IP address from the DHCP server in the network.
 - For static IP, enter IP Address, Subnet Mask, Default Gateway, DNS Server and Alternative DNS server for the GXV3350 to correctly connect to network.
 - For PPPoE, enter PPPoE account ID and password so the GXV3350 can get IP address from the PPPoE server.

WI-FI

WI-FI is supported and built-in on the GXV3350. GXV3350 can be connected to network if Wi-Fi is available within the area.

Turn On/Off Wi-Fi

1. Go to GXV3350's **Settings**.
2. Touch **Network**.
3. Check or uncheck the option for **Wi-Fi**.

Or, users could open the top status bar and tap on Wi-Fi icon  to turn it on/off.

Connect to Wi-Fi Networks

1. Once Wi-Fi is turned on, GXV3350 will automatically start the scanning within the range.
2. Go to GXV3350's **Settings**.



3. Touch **Network**.
4. Touch **Wi-Fi Settings**.
5. A list of Wi-Fi networks will be displayed as scanning result. Tap on the SSID and enter the correct password information to connect to the selected Wi-Fi network.
6. The phone will start connecting to the Wi-Fi. The status bar will show Wi-Fi signal strength.
7. Once it's added and the password is remembered, the GXV3350 will connect to it again when the SSID is within the range.

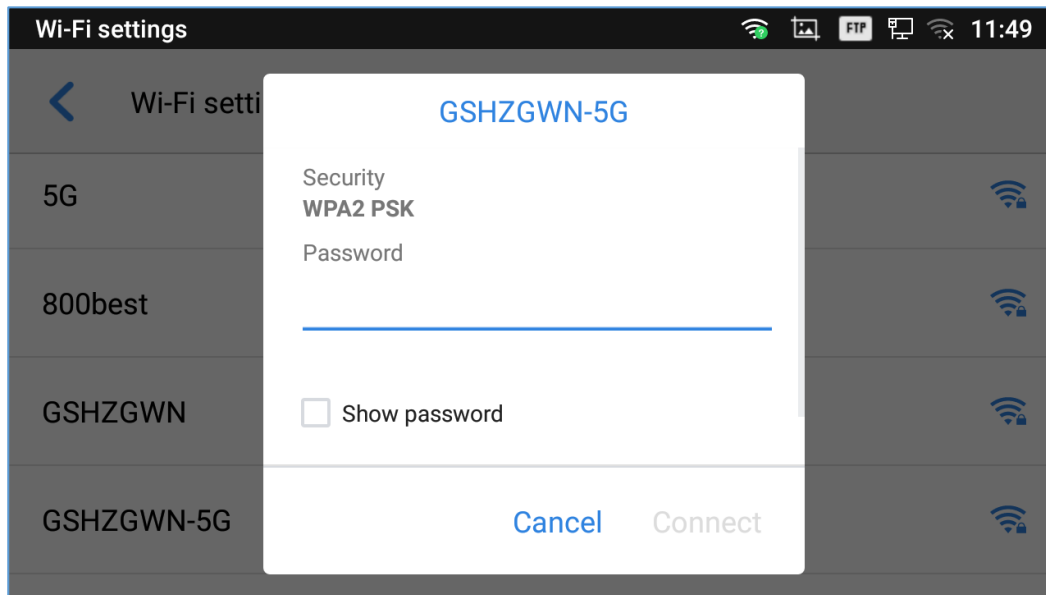

Figure 140: GXV3350 Connect to Wi-Fi

8. The previous steps allow the GXV3350 to connect the Wi-Fi network with DHCP setting by default. If it needs to be connected the Wi-Fi with static IP settings, please scroll down the setting window and tap to check the **“Advanced options”**. Then the window will show up the IP settings at the bottom. If the Static is selected, the system will require end user to input IP address, Gateway, Network prefix length and DNS 1 and DNS 2 addresses.

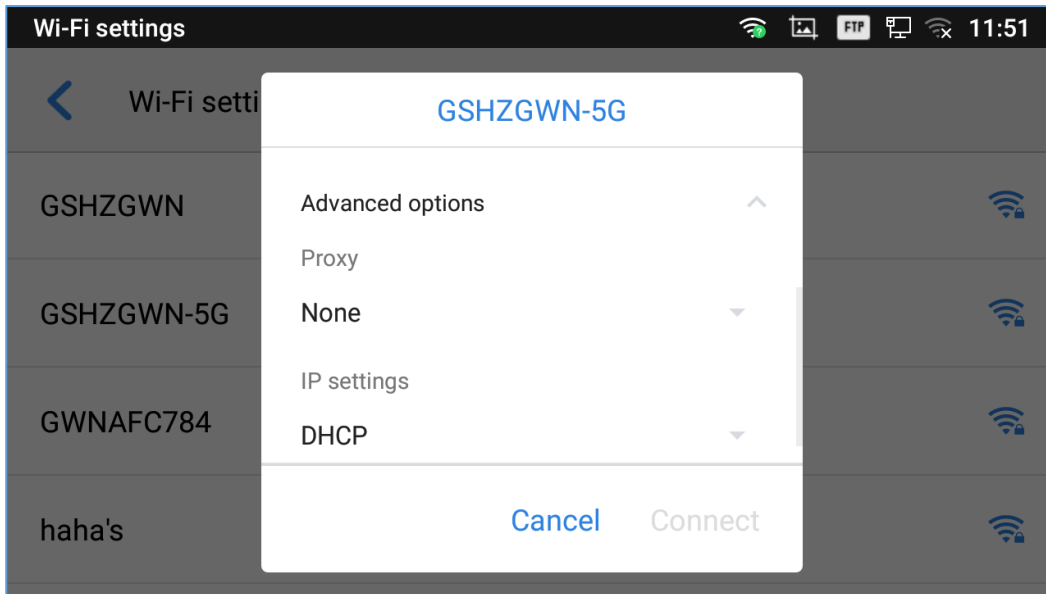

Figure 141: GXV3350 Connect to Wi-Fi-Show Advanced Options

9. If there is a need to modify the saved Wi-Fi network setting, the end user should tap and long press the SSID bar in the Wi-Fi setting page. The system will pop up a prompt and then users need to tap on **“Modify Network”**. Then, the phone system will pop up a new window to allow user to check the Wi-Fi parameters and change the setting by checking the **“Advanced options”** at the bottom.
10. User can also add Wi-Fi Networks manually if the network is hidden or not showing on the list of scanned SSIDs. User needs to roll down the Wi-Fi settings page and press on **“Add network”** and then enter the SSID name, Security type and Password.

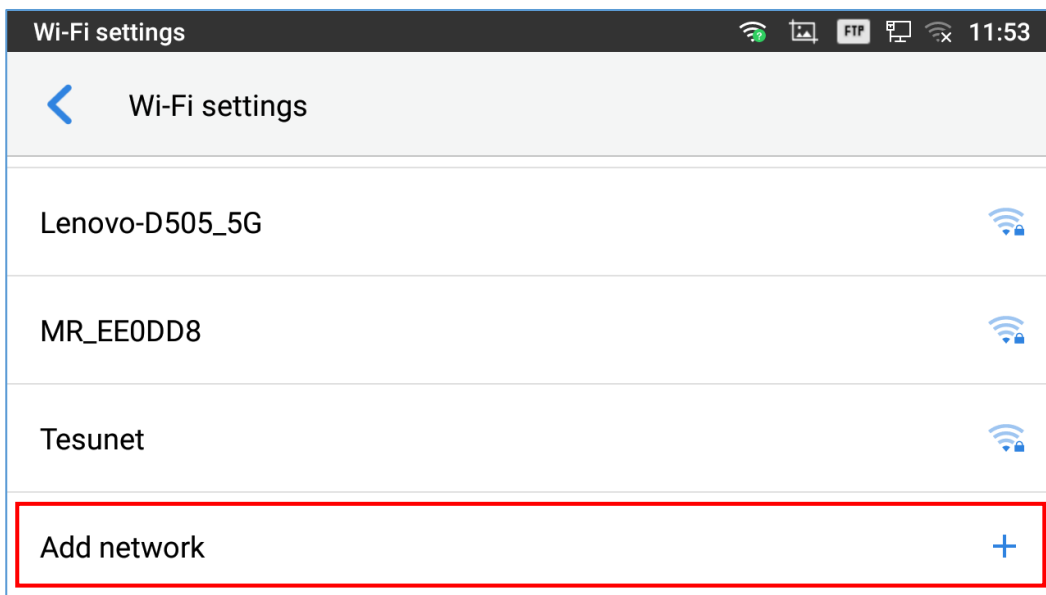

Figure 142: Wi-Fi - Add network

Wi-Fi Settings Shortcut

Users can enter the Wi-Fi settings by sliding the Status Bar, then long press on the Wi-Fi icon.

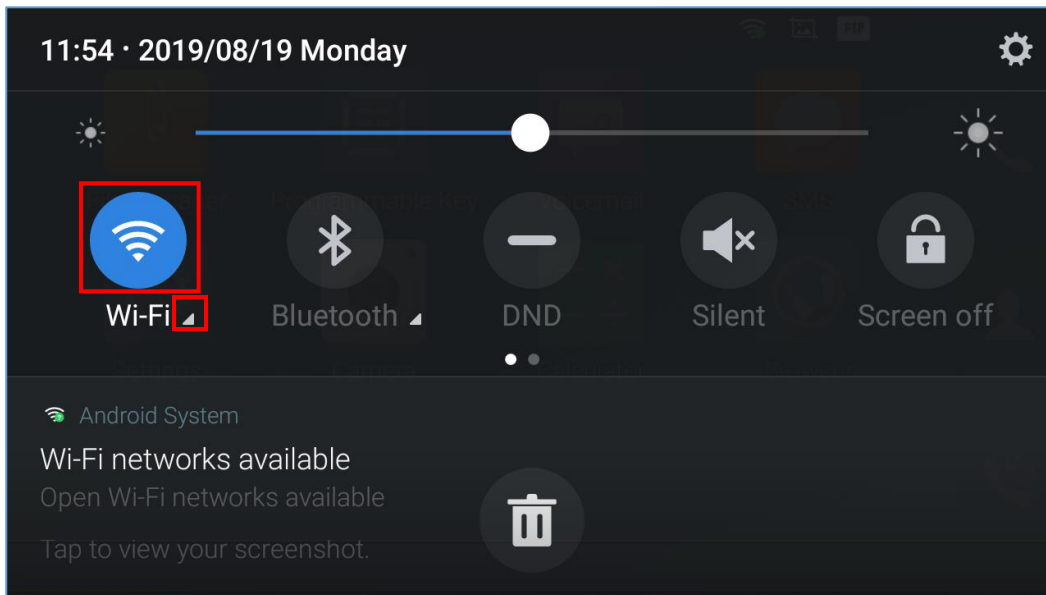

Figure 143: Wi-Fi Settings Shortcut

-Or-

Press the letter under Wi-Fi icon this will show the list of the Wi-Fi networks detected. Press “More Settings” to access the Wi-Fi settings.

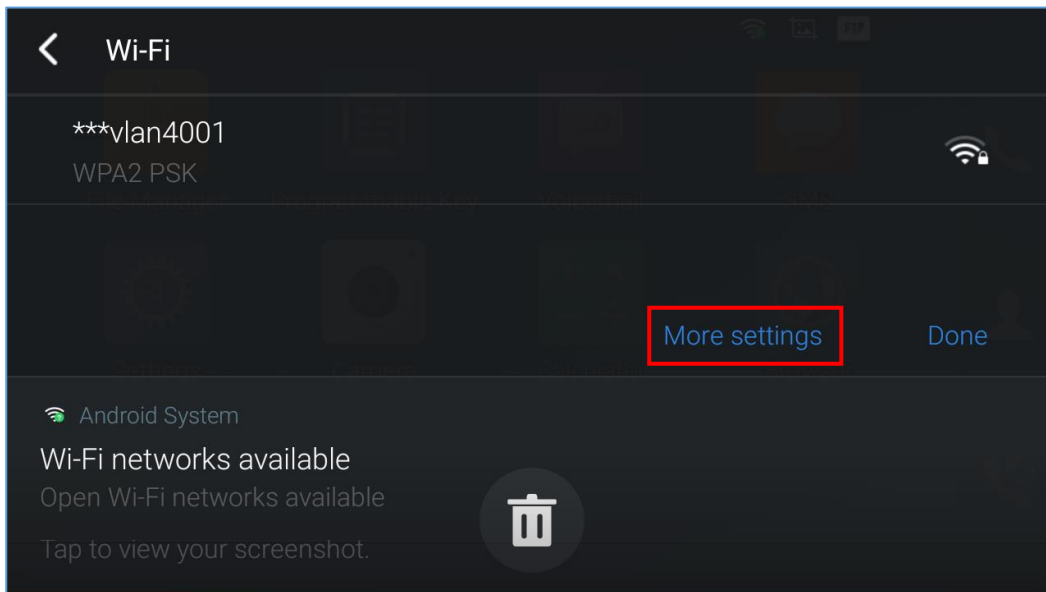

Figure 144: Wi-Fi Shortcut - Wi-Fi List

For more information about how to use Wi-Fi on the GXV3350, please refer to the link below:

http://www.grandstream.com/sites/default/files/Resources/gxv3275_wifi_guide_0.pdf

Bluetooth

Bluetooth is a proprietary, open wireless technology standard for exchanging data over short distances from fixed and mobile devices, creating personal area networks with high levels of security. The GXV3350 supports Bluetooth, version 4.2 + EDR. Users could use Bluetooth to transfer files, share contact information with other Bluetooth portable devices, use Bluetooth headset for making calls, switch calls to the GXV3350 from mobile devices using Bluetooth hands-free profile, and listen to media (music or other audio output) from the GXV3350.

To connect to a Bluetooth device, turn on GXV3350's Bluetooth radio first. The first time when using a new Bluetooth device with the GXV3350, "pair" the device with GXV3350 so that both devices know how to connect securely to each other. After that, users could simply connect to a paired device. Turn off Bluetooth if it's not used.

Bluetooth settings are under GXV3350's **Settings**→**Features**→**Bluetooth**.

Turn On/Off Bluetooth

1. Go to GXV3350's **Settings** → **Features** → **Bluetooth**.
2. Check or uncheck Bluetooth option.

Or, users could open the top status bar→ tap on Bluetooth icon  to turn it on/off.

Change Bluetooth Device Name

The GXV3350 uses "GXV3350_XXXXXY" as Bluetooth device name by default where "XXXXX" is the last 6 digits of the phone's MAC address and the "Y" is the last 6th digit plus 2. The device name will be visible to other devices when connecting them. Follow the steps below to change the name:

1. Go to GXV3350's **Settings**→**Features**→**Bluetooth**
2. Turn on **Bluetooth**.
3. Select **Additional settings**.
4. Press "Device name".
5. Enter a name and tap on "Rename".

Pair GXV3350 with a Bluetooth Device

Before connecting GXV3350 with other Bluetooth device, users must pair them first. They will stay paired afterwards unless they are unpaired.

1. Go to GXV3350's **Settings** → **Features** → **Bluetooth**



2. Turn on **Bluetooth**.
3. Tap **Additional settings** and select “Visible to nearby Bluetooth devices” to make the GXV3350 phone visible to all nearby Bluetooth devices.
4. The GXV3350 scans and displays the IDs of all available Bluetooth devices in range. If the device you would like to pair with does not show up in the list (available devices), ensure that the other device is turned on and set to be discoverable.
5. If the GXV3350 stops scanning before the other device is ready, press  button to scan again.
6. Once the Bluetooth device shows up in the result, tap on it to start pairing. Confirm the passkey in the prompted message (if any). Or if passcode is required, please refer to the device's documentation or other procedures to obtain the passcode.

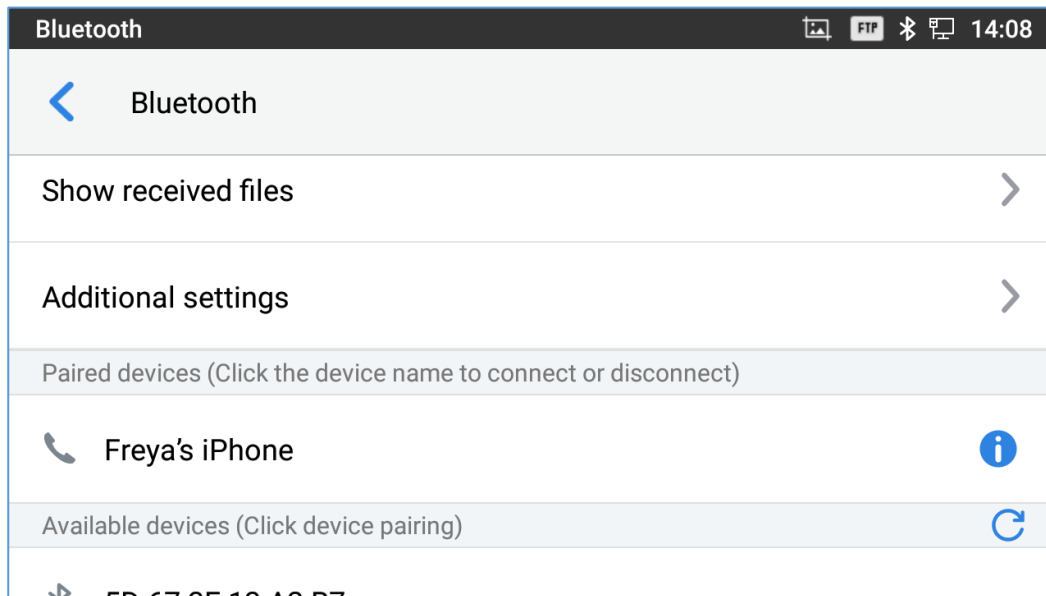



Figure 145: GXV3350 Bluetooth - Paired Device

Unpair a Bluetooth Device

1. In the Bluetooth settings, tap on  button corresponding to the Bluetooth device.
2. Select **Unpair**.

Bluetooth Settings Shortcut

User can enter the Bluetooth settings by sliding the Status Bar, then long Press on the Bluetooth icon.

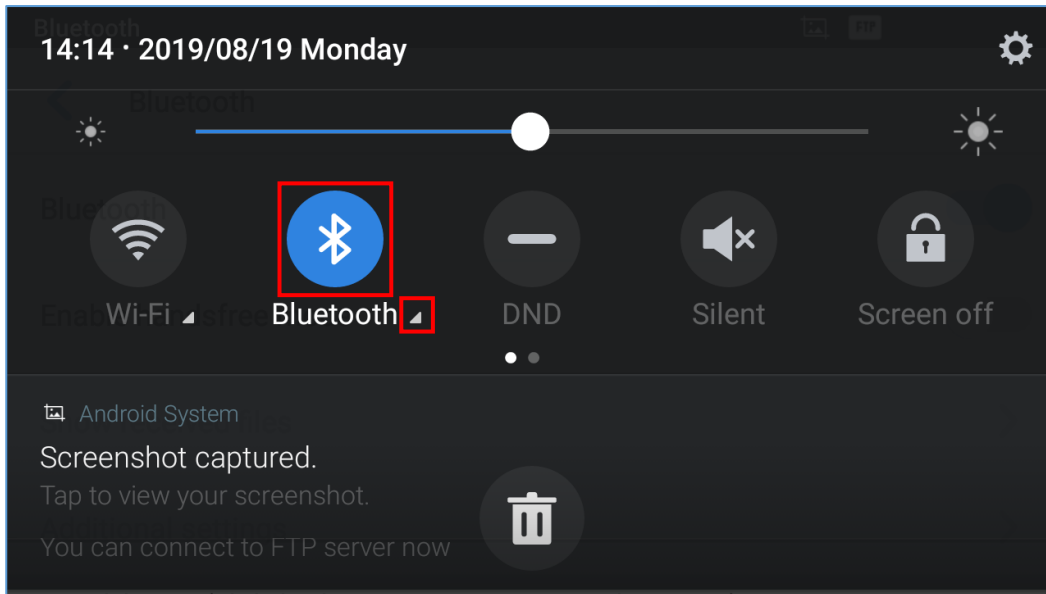

Figure 146: Bluetooth Settings Shortcut

-Or-

Press the letter under Bluetooth icon this will show the list of the paired devices. Press “More Settings” to access the Bluetooth settings.

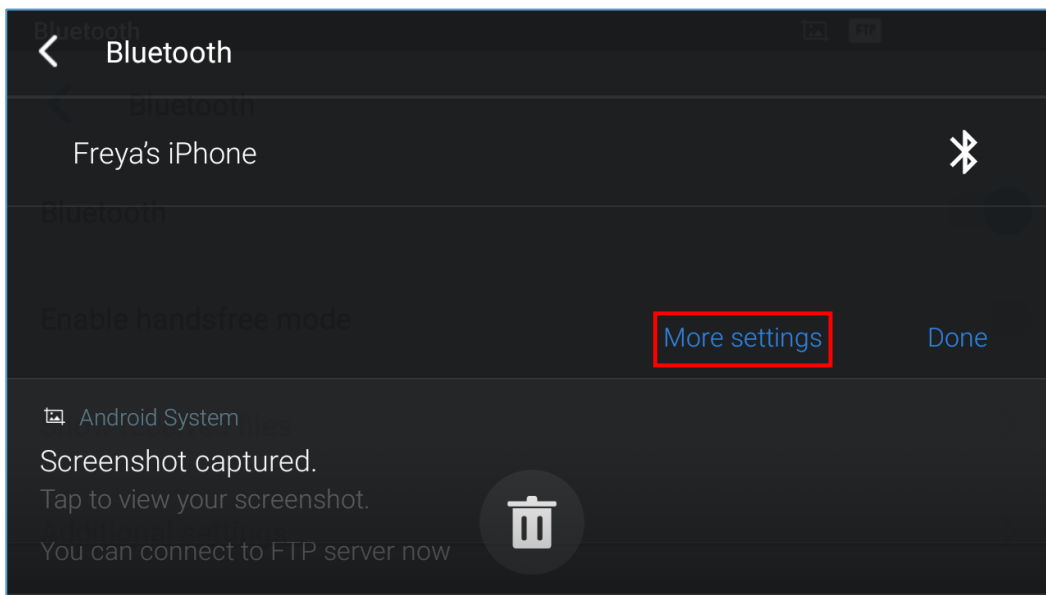

Figure 147: Bluetooth Setting shortcut 2

For more information about Bluetooth feature on the GXV3350, please refer to the link below:
http://www.grandstream.com/sites/default/files/Resources/gxv3275_bluetooth_guide_1.pdf

EHS Headset

The GXV3350 supports normal RJ9 headset and EHS headset. To use Plantronics EHS headset:

1. Go to the GXV3350 Home screen → **Settings** → **Basic** → **Peripherals**: enable option “Plug RJ9/EHS headset”
2. Connect EHS Headset to the GXV3350. Insert headset connector into the RJ9 headset port on the back of GXV3350.

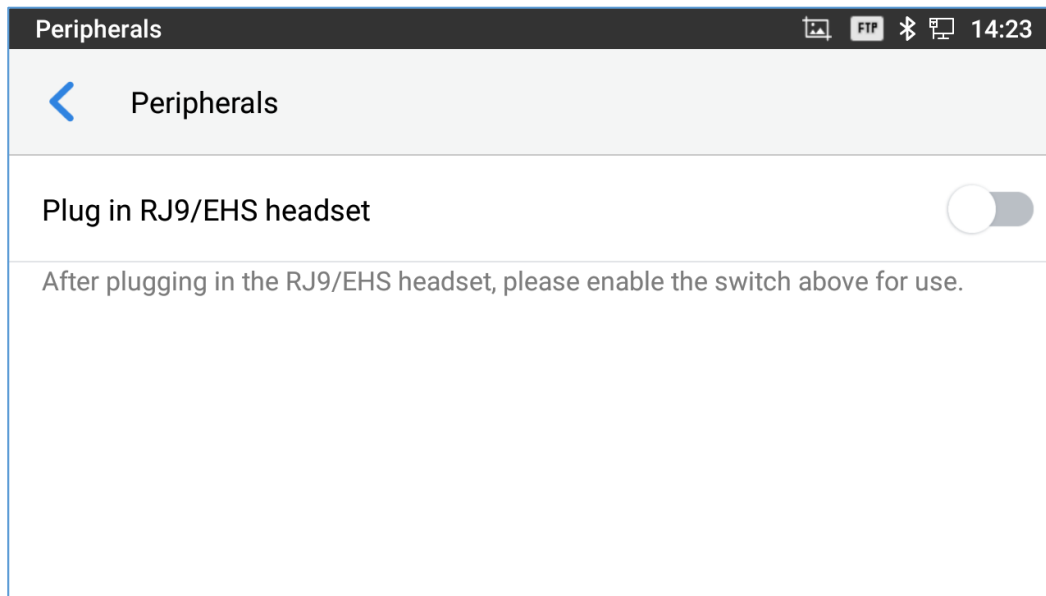

Figure 148: EHS headset

USB Headset

The GXV3350 supports USB Headset, once the headset plugged and tap on the Headset button, it will be detected, then the following icon will be shown on the top right of the status bar, this means a USB headset is connected.

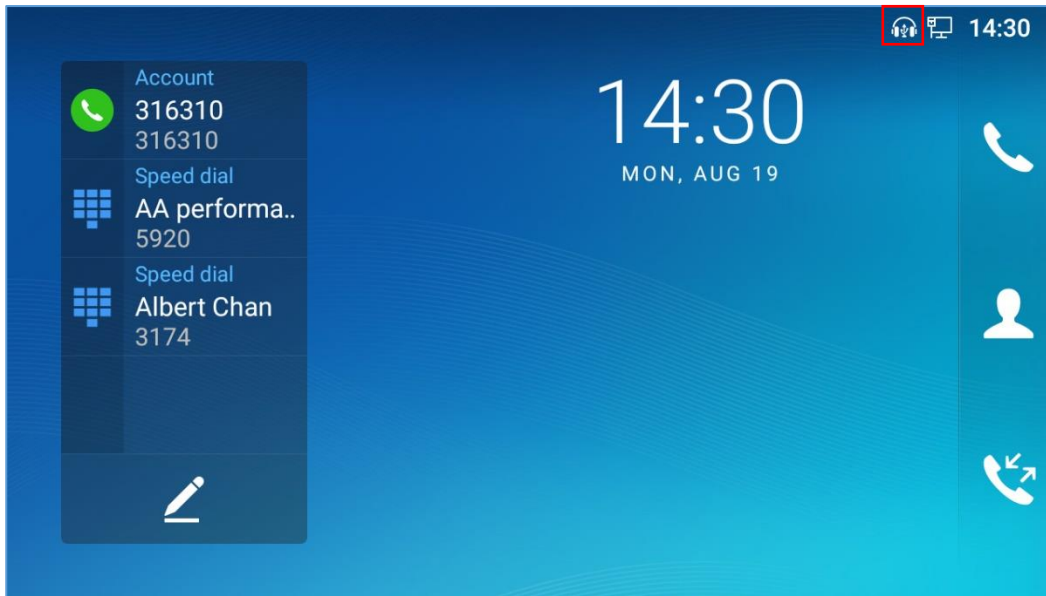

Figure 149: USB Headset Connected

In the calling page, user can press on the Headset button (shown in figure below) when plugging in USB headset to enable USB headset. The status bar shows the icon modified indicating that the USB headset is being used for speaking.

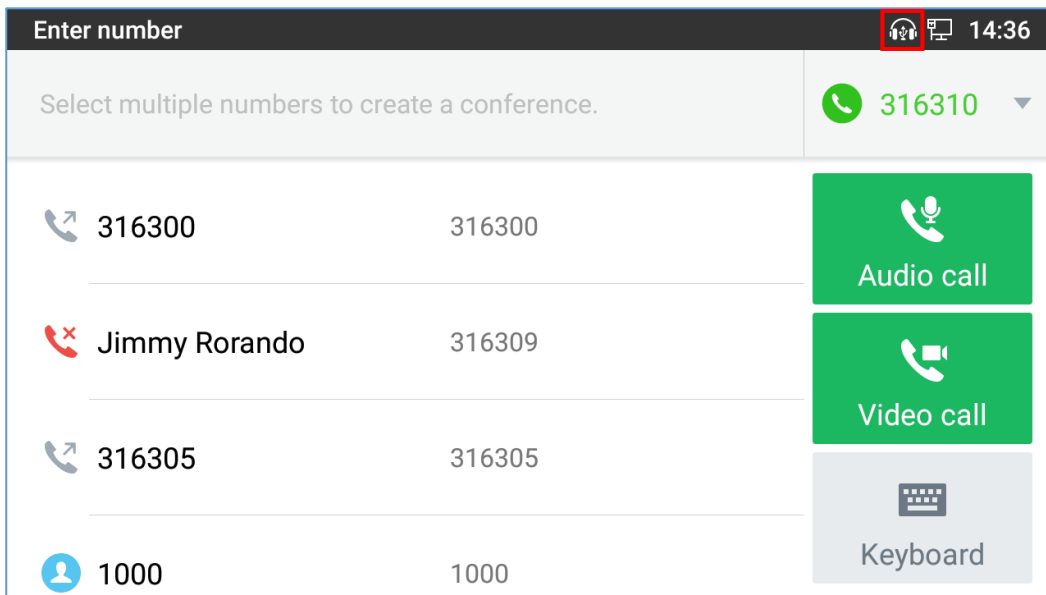



Figure 150: USB Headset Used for Call

During the call, users can tap on “**Headset**” to toggle between Speaker and USB Headset.

USB

The GXV3350 supports USB connection with USB storage devices. To connect and access USB storage device:



1. Insert an USB storage device into USB port at the back of the GXV3350.
2. It will take a few seconds for the GXV3350 to prepare the connection. Then the USB storage icon  will show on the status bar.
3. To access USB storage, go to GXV3350 MENU → **File Manager** → **USB**. Tap on it to access and manage your data.

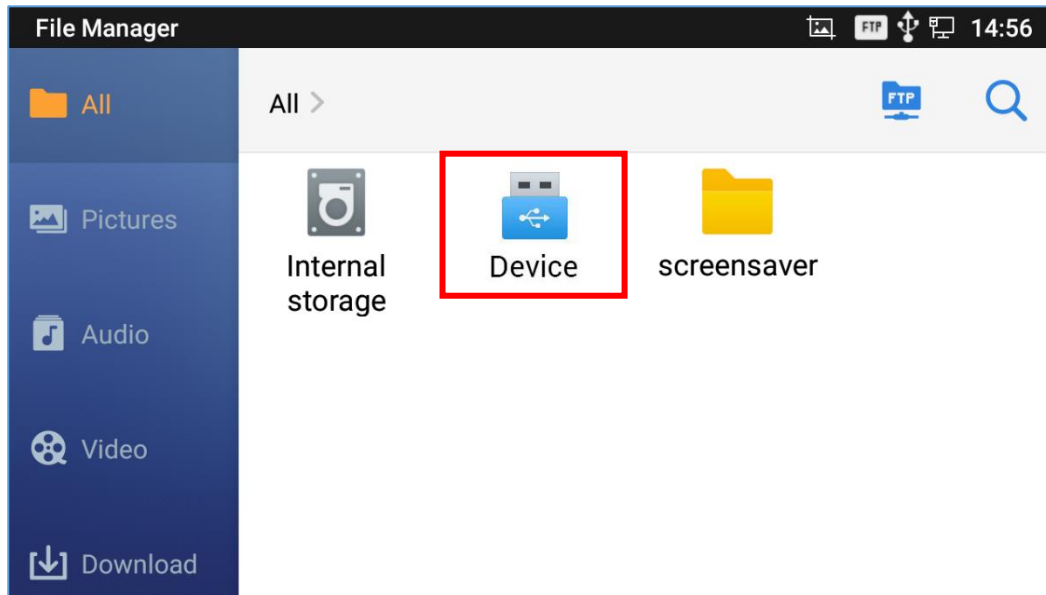

Figure 151: USB Storage Device Connected to GXV3350

EMERGENCY CALL

Users could configure Emergency Call Numbers on **GXV3350 Web GUI →System Application→Contacts→General Settings**, in order to still being able to call those numbers even when the phone is locked. Emergency call interface can be accessed by tapping on “EMERGENCY” under the GXV3350 locked screen. Please, refer to the following figure:



Figure 152: Emergency Access under GXV3350 Locked Screen

Once “EMERGENCY” is pressed, a dial screen will show and users can choose the numbers allowed to be dialed from the list on the left of the dial screen.

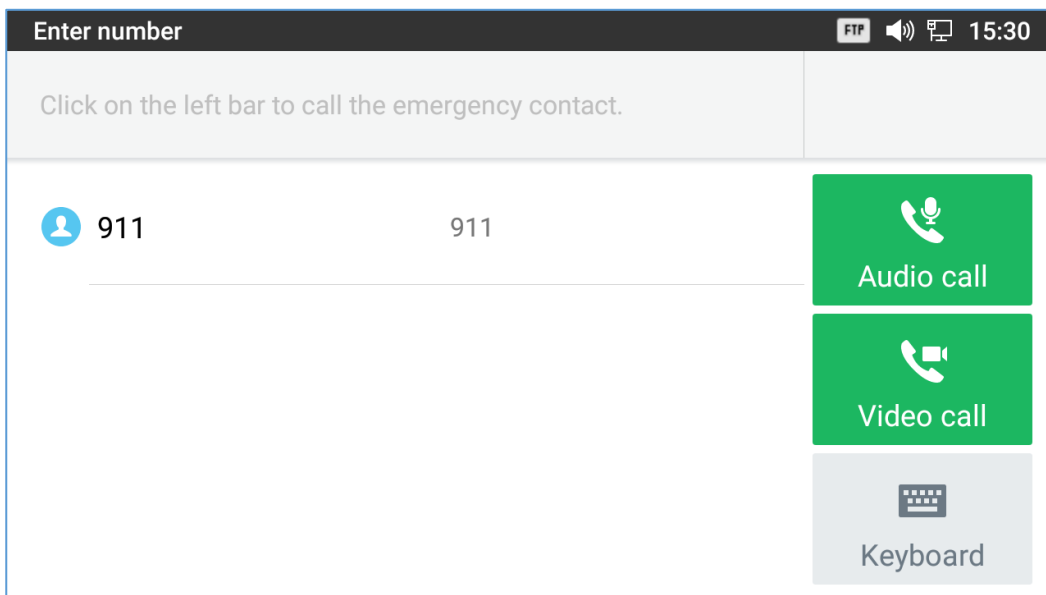

Figure 153: Emergency Dial Screen

Note: The GXV3350 is not pre-configured to support or carry emergency calls to any type of hospital, law enforcement agency, medical care unit (“Emergency Service(s)”) or any other kind of Emergency Service. You must make additional arrangements to access Emergency Services. It is your responsibility to purchase SIP-compliant Internet telephone service, properly configure the GXV3350 to use that service, and periodically test your configuration to confirm that it works as you expect. If you do not do so, it is your responsibility to purchase traditional wireless or landline telephone services to access Emergency Services.



EXPERIENCING THE GXV3350 APPLICATION PHONE

Please visit our website: <http://www.grandstream.com> to receive the most up- to-date updates on firmware releases, additional features, FAQs, documentation and news on new products.

We encourage you to browse our [product related documentation](#), [FAQs](#) and [User and Developer Forum](#) for answers to your general questions. If you have purchased our products through a Grandstream Certified Partner or Reseller, please contact them directly for immediate support.

Our technical support staff is trained and ready to answer all your questions. Contact a technical support member or [submit a trouble ticket online](#) to receive in-depth support.

Thank you again for purchasing Grandstream Enterprise Application phone, it will be sure to bring convenience and color to both your business and personal life.

* Android is a trademark of Google LLC.

* Skype and Skype for Business are Registered Trademarks of Microsoft Corporation.

© 2002-2014 OpenVPN Technologies, Inc.

OpenVPN is a registered trademark of OpenVPN Technologies, Inc.



HDMI, the HDMI Logo, and High-Definition Multimedia Interface are trademarks or registered trademarks of HDMI Licensing LLC in the United States and other countries.

